

IB-5395 PLB  
GESAMTANSICHT

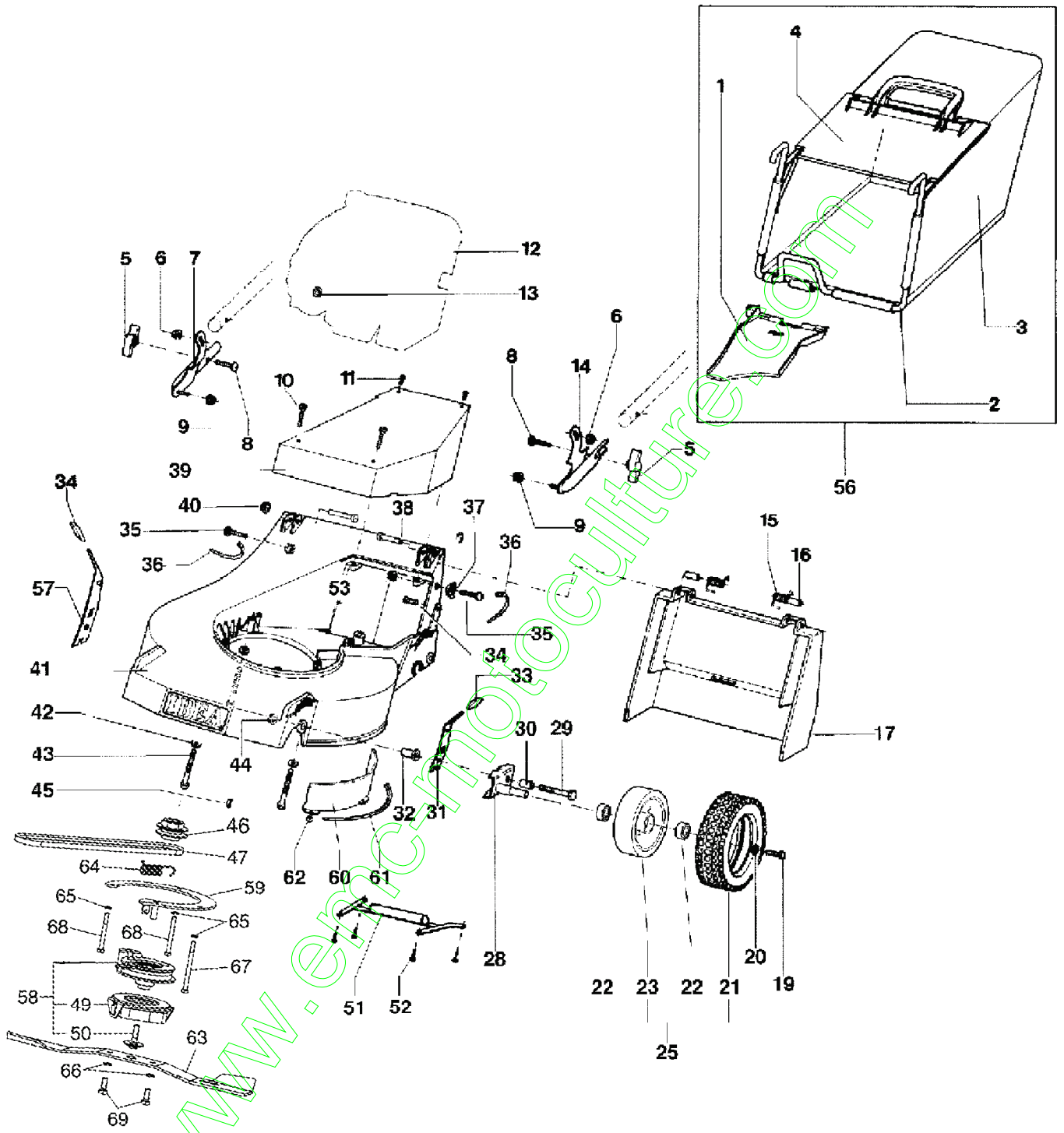

IB-5395 PLB  
GESAMTANSICHT

---

Bild Nr.	Teile Nr.	Anzahl	Beschreibung
1	P2020187	1	LEITBLECH
2	P00011098	1	GESTELL
3	P3160043	1	GRASFANGSACK
4	P2020149	1	ABWEISER
5	2020050A1	2	MUTTER
6	P1050011	2	MUTTER
7	P3120095VEN	1	FÜHRUNGSHOLM, UN. R.
8	P1010153	2	SCHRAUBE
9	P1050011	2	MUTTER
10	P1010260	2	SCHRAUBE
11	P1010071	2	SCHRAUBE
12	MOTORE	1	MOTOR
13	P1050011	3	MUTTER
14	P3120096VEN	1	FÜHRUNGSHOLM, UN. L.
15	P3020027	2	FEDER
16	P3140238	2	ABSTANDSSTÜCK
17	P2020189	1	KLAPPE
19	P1010119	2	SCHRAUBE
20	1020009A1	2	FEDERSCHEIBE
21	P2020083	2	REIFEN
22	P3030025	4	LAGER
23	P2060003	2	FELGE
25	P2080010	2	RAD KOMPL.
28	P4020030	2	RADHALTER
29	P1010116	2	SCHRAUBE
30	P3040118	2	BÜCHSE
31	P4020039	1	RADHEBEL L.
32	P3040119	2	BÜCHSE
33	P2020077	2	ABDECKUNG
34	P1010079	2	SCHRAUBE
35	P1010122	2	SCHRAUBE
36	5040001A1	2	RAPBAND
37	P2020087	2	RING
38	P1080018	2	STIFT
39	P2020188	1	KEILRIEMEN
40	P1060004	2	STARLOCK
41	P4090019	1	GEHÄUSE
42	1020014A1	3	SCHEIBE
43	P1010097	2	SCHRAUBE
43	P1010098	1	SCHRAUBE
44	P1050012	2	MUTTER
45	1090001A1	1	FEDERKEIL
46	P3040700BR	1	RIEMENSCHLEIBE
47	P3010020	1	RIEMEN
49	P3140004	1	UNTERBREMS-MESSER
50	P1010387	1	SCHRAUBE
51	P3060114	1	VERSTEIFUNG
52	P990-51050-103	4	SCHRAUBE

---

IB-5395 PLB  
GESAMTANSICHT

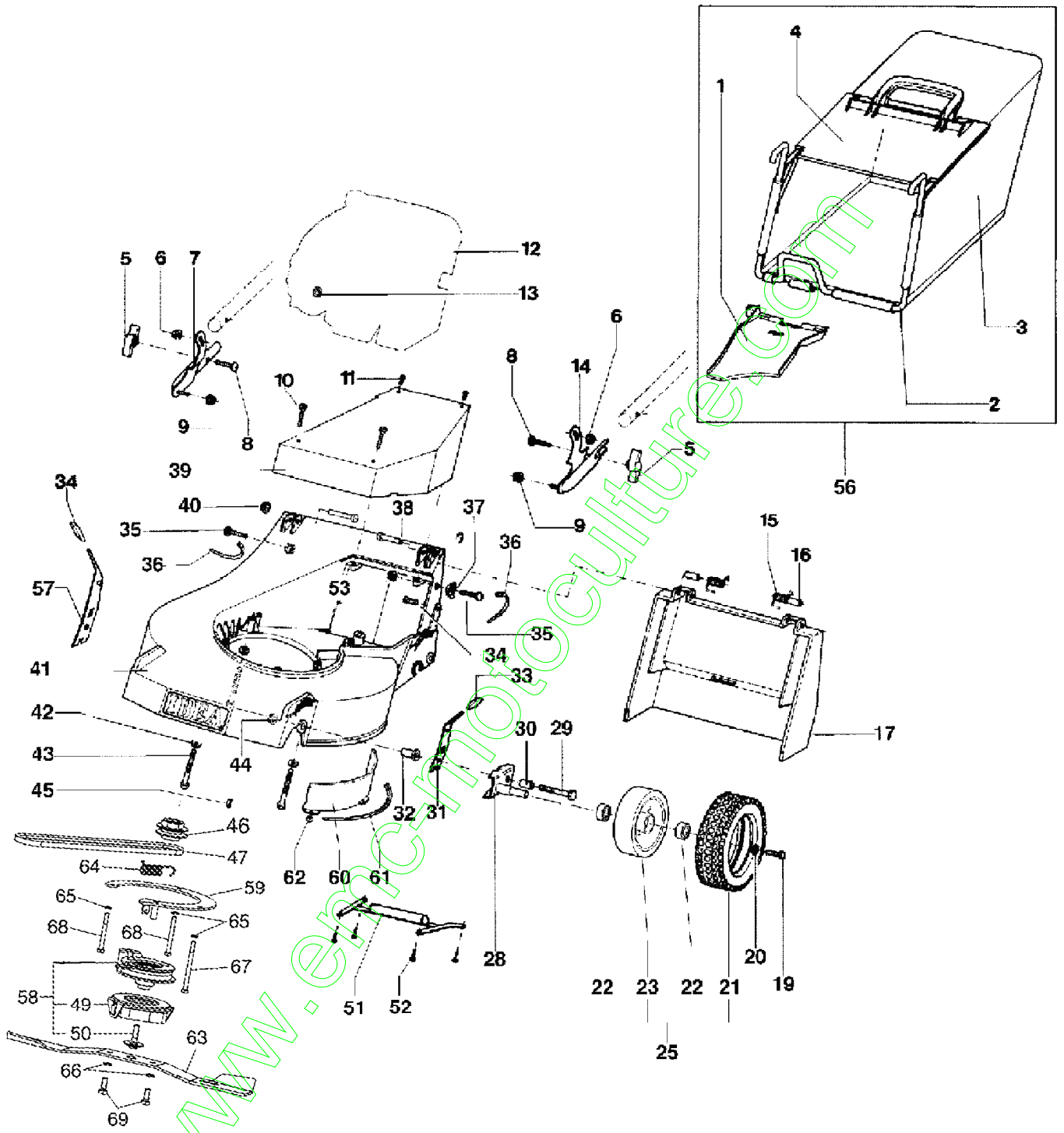

IB-5395 PLB  
GESAMTANSICHT

---

Bild Nr.	Teile Nr.	Anzahl	Beschreibung
53	1050002A1	2	MUTTER
56	P00010098	1	GRASFANGSACK KOMP.
57	P4020038	1	RADHEBEL R.
58	P3140002	1	MOTORBREMSE
59	P3090147ZB	1	PLATTE
60	P01082352	1	VERSTÄRKUNG
61	P01082252	2	VERSTÄRKUNG
62	P1010018	6	SCHRAUBE
63	P4050034VE	1	MESSER
64	P3020090ZB	1	FEDER
65	P1020117	3	FEDERSCHEIBE
66	P1020134	2	SCHEIBE
67	P1010098	1	SCHRAUBE
68	P1010097	2	SCHRAUBE
69	P1010197	2	SCHRAUBE

[www.emc-motoculture.com](http://www.emc-motoculture.com)

---

IB-5395 PLB  
HINTERACHSE

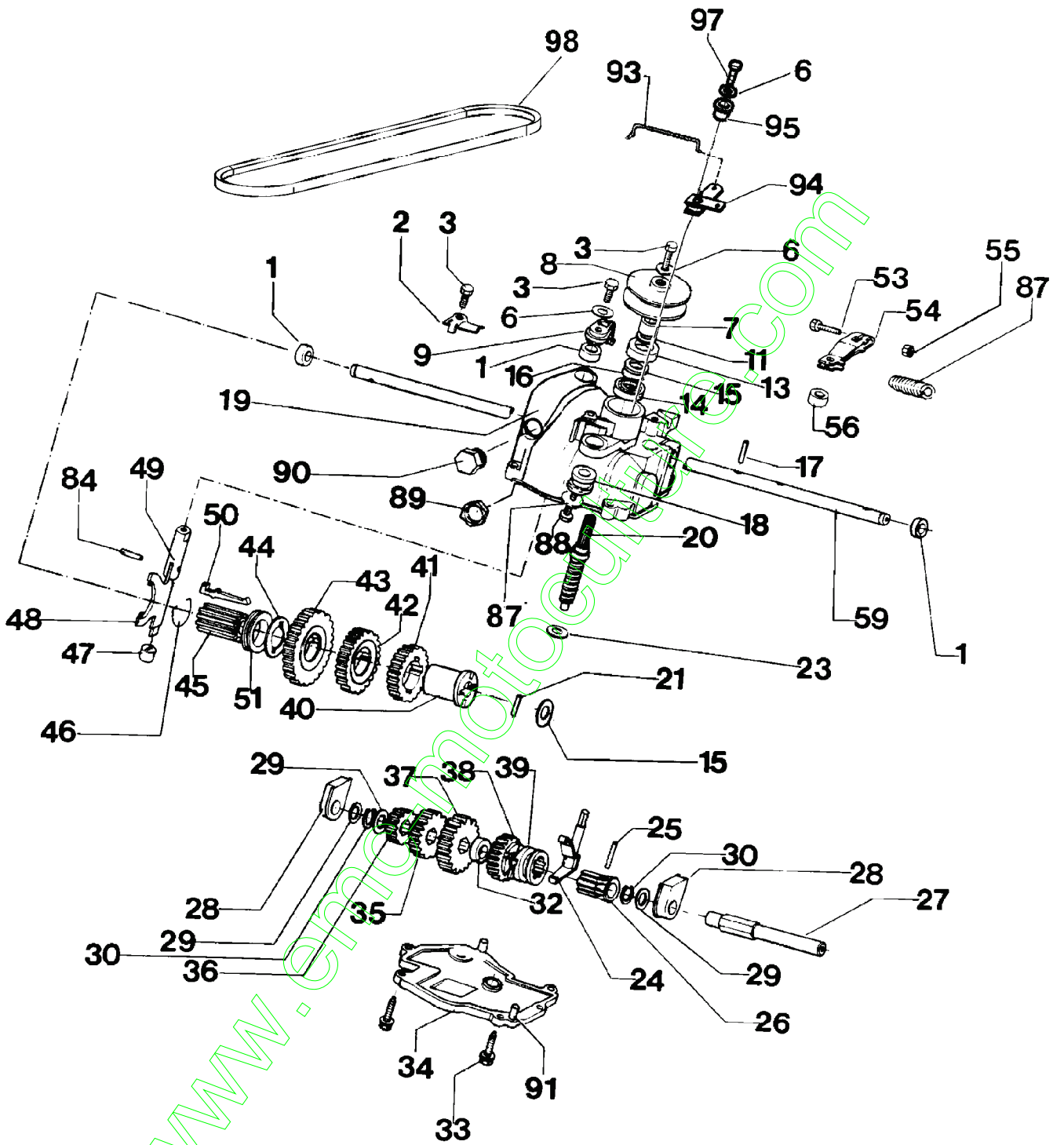

IB-5395 PLB  
HINTERACHSE

---

Bild Nr.	Teile Nr.	Anzahl	Beschreibung
1	P3170011	3	DICHTUNG
2	P4010124	1	DECKEL
3	1010018A1	3	SCHRAUBE
6	1020007A1	3	FEDERSCHEIBE
7	P3040049	1	BÜCHSE
8	P3040244	1	RIEMENSCHLEIFE
9	P2020414	1	HEBEL
11	P3170013	1	GUMMIRING
13	P3170010	1	WELLENDICHTRING
14	P3030010	1	LAGER
15	P1020079	2	PASSSCHEIBE
16	P1070004	1	SEEGER
17	P1080015	1	SPANNHÜLSE
18	P2040010	1	SCHUTZHÜLLE
19	P00039219	1	GETRIEBEGEHÄUSE
20	P3040207	1	SCHRAUBE
21	P1080007	1	STIFT
23	P1020053	1	ABSTANDSSTÜCK
24	P3040041	1	GABEL
25	P1080013	1	BOLZEN
26	P00065452	1	BUCHSE
27	P3040205	1	WELLE
28	P3050036	2	HALTER
29	1020020A1	2	ABSTANDSSTÜCK
30	1070001A1	2	SEEGER
32	P3040206	1	DISTANZBUCHSE
33	P1010225	6	SCHRAUBE
34	P3050100	1	DECKEL
35	P3050041	1	STIRNRAD
36	P3050040	1	STIRNRAD
37	P3050042	1	STIRNRAD
38	P00038119	1	STIRNRAD
39	P00037952	1	SCHALTBUCHSE
40	P3050038	1	BUCHSE
41	P3050045	1	STIRNRAD
42	P3050044	1	STIRNRAD
43	P3050043	1	STIRNRAD
44	P4010121	1	RING GEHÄRTET
45	P2020161	1	BUCHSE
46	P3020024	1	SEEGERRING
47	P3050046	1	UNTERE FÜHRUNG
48	P4010122	1	ANLAUFHEBEL
49	P3040216	1	OBERE FÜHRUNG
50	P3050039	1	SCHALTFINGER
51	P3040204	1	ANLAUFRING
53	P1010157	1	SCHRAUBE
54	P4010123	1	ANTRIEBSHEBEL
55	1050002A1	1	MUTTER

---

IB-5395 PLB  
HINTERACHSE

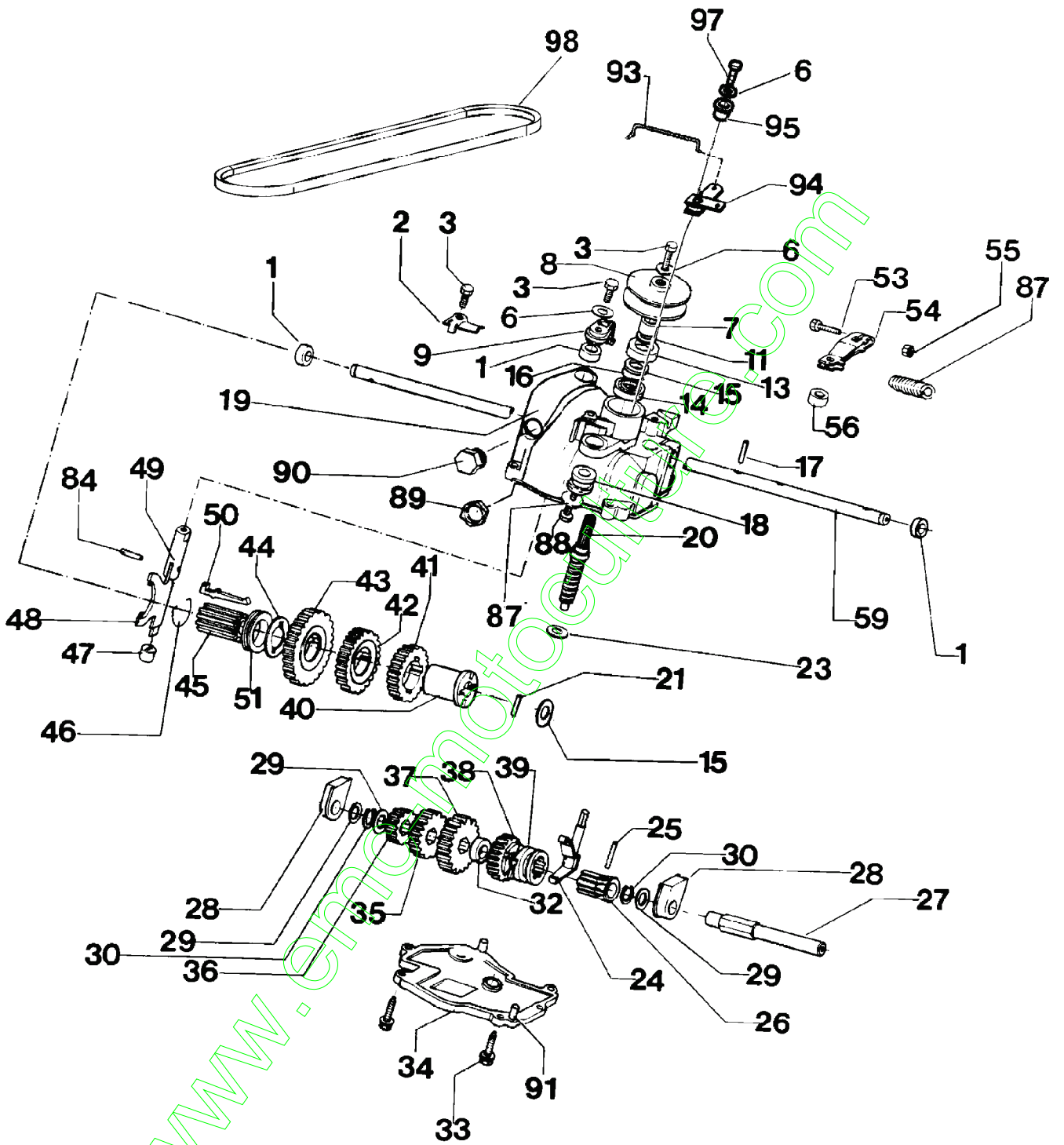

IB-5395 PLB  
HINTERACHSE

---

Bild Nr.	Teile Nr.	Anzahl	Beschreibung
56	P3170012	1	WELLENDICHTRING
59	P3040293	1	ANTRIEBSWELLE
84	1010018A1	1	SCHRAUBE
87	P1020054	1	SCHEIBE
88	P1010173	1	SCHRAUBE
89	P3040264	1	NUTMUTTER
90	P5060003	1	ÖLSTANDANZEIGER
91	P1080014	2	BOLZEN
93	P3100138ZT	1	STANGE
94	P3060113	1	HEBEL
95	P3040426	1	BUCHSE
97	P1010075	1	SCHRAUBE
98	P3010020	1	RIEMEN
*	P3090114	1	FAHRGETRIEBE KOMPL.

[www.emc-motoculture.com](http://www.emc-motoculture.com)

---



IB-5395 PLB  
HINTER RAD

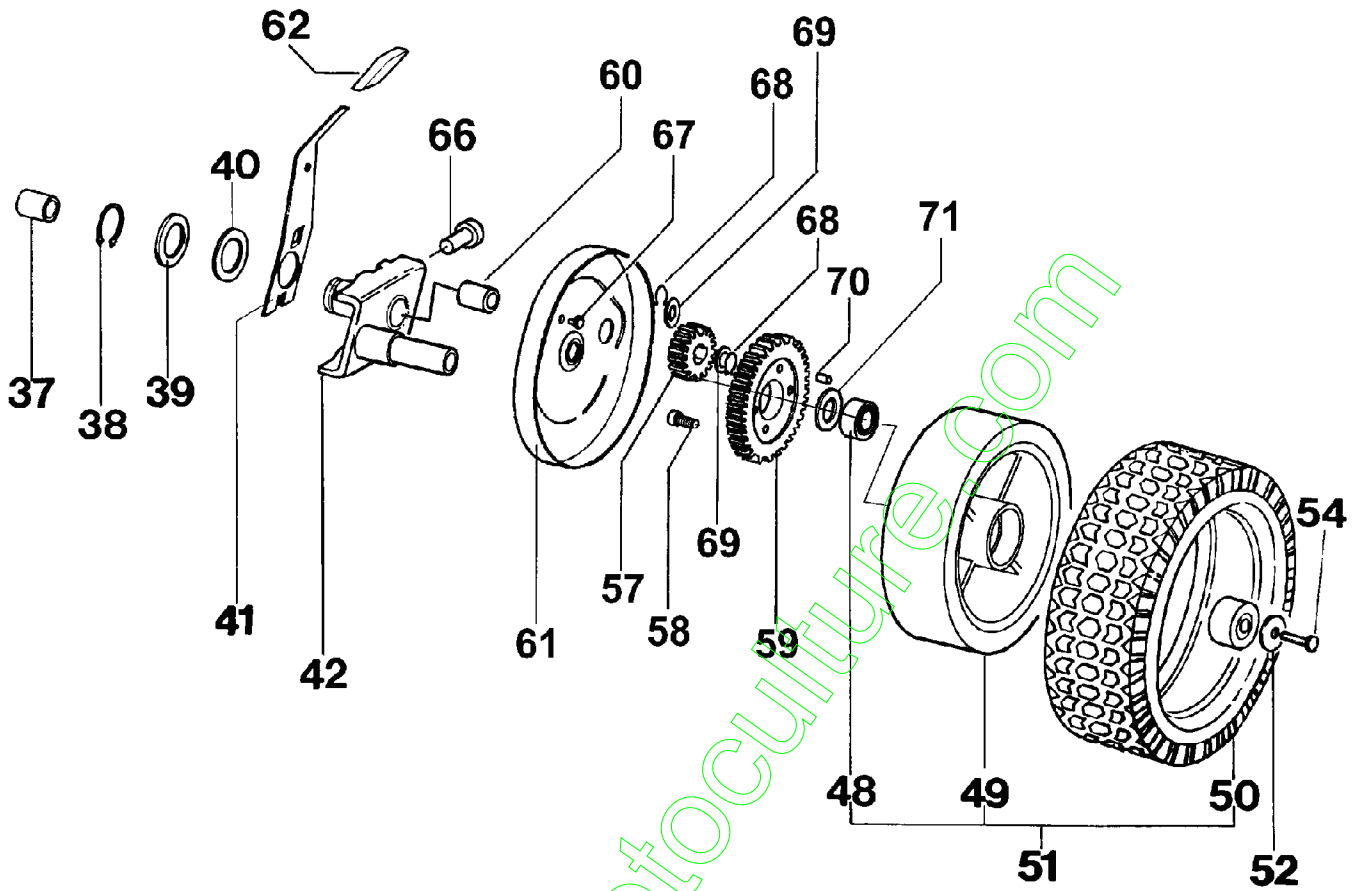

IB-5395 PLB  
HINTER RAD

---

Bild Nr.	Teile Nr.	Anzahl	Beschreibung
37	3030003A1	2	LAGER
38	1070001A1	2	SEEGER
39	P1020057	2	ABSTANDSSTÜCK
40	P3040121	2	DISTANZBUCHSE
41	P4020019	1	RADHEBEL L.
41	P4020020	1	RADHEBEL R.
42	P4020122	2	HINTERRADHALTER
48	P3030025	4	LAGER
49	P2060004	2	FELGE
50	P2020083	2	REIFEN
51	P2080013	2	RAD KOMPL.
52	1020009A1	2	FEDERSCHEIBE
54	P1010119	2	SCHRAUBE
57	P3050034	2	RITZEL
58	P1010121	4	SCHRAUBE
59	P3050033	2	KRONENRAD
60	3030003A1	2	LAGER
61	P2020442	2	ABDECKUNG
62	P2020077	4	ABDECKUNG
66	P1010143	2	SCHMIERNIPPEL
67	P1020086	2	NIET
68	1070001A1	4	SEEGER
69	1020020A1	4	ABSTANDSSTÜCK
70	P1080010	4	BOLZEN
71	P1020110	4	SCHEIBE

www.emc-motoculture.com

---

IB-5395 PLB  
LENKERBERTEIL

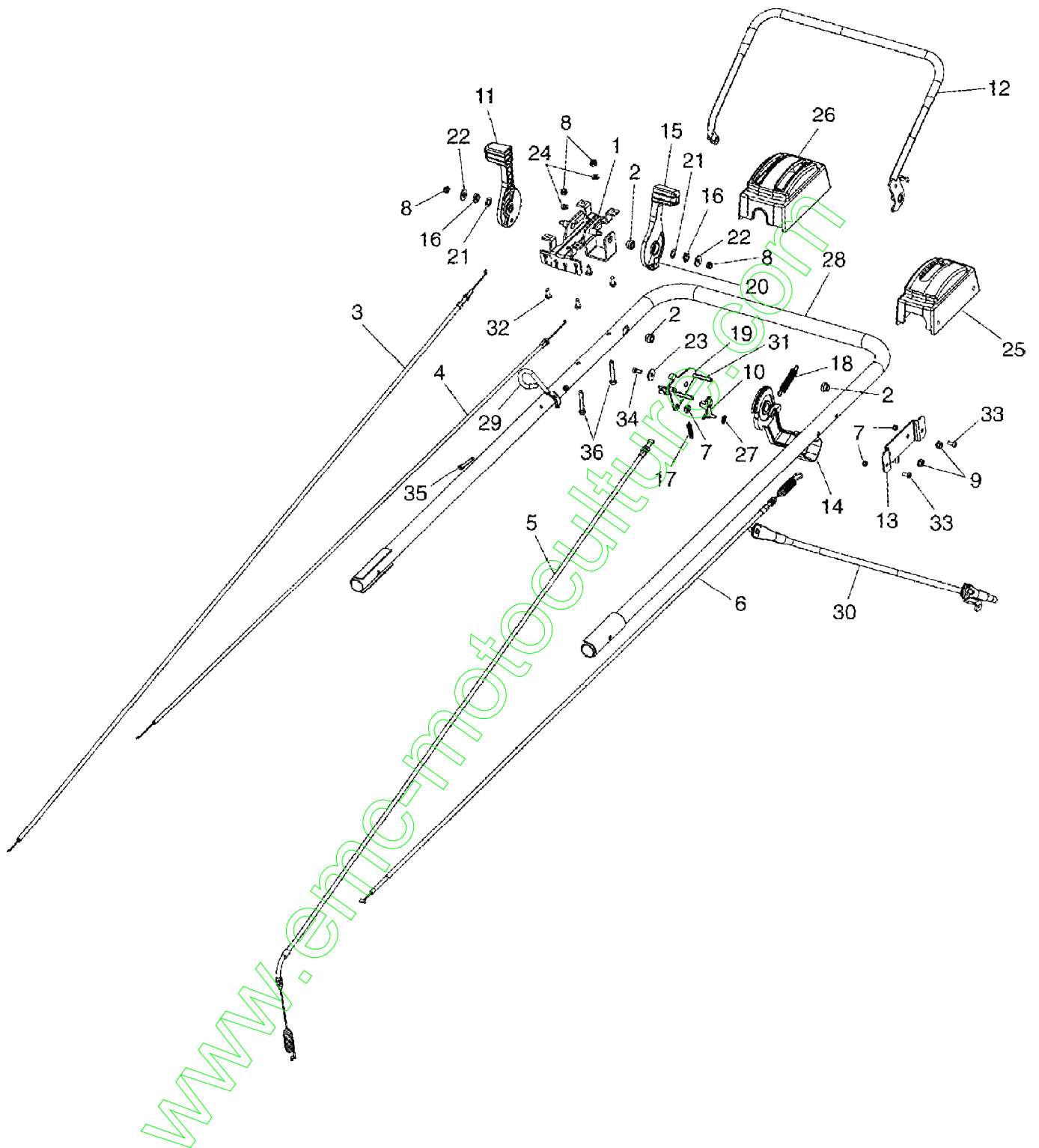

IB-5395 PLB  
LENKERBERTEIL

---

Bild Nr.	Teile Nr.	Anzahl	Beschreibung
1	P3090146ZN	1	HALTER
2	P3040733	3	BÜCHSE
3	P5010119	1	GANGKABEL
4	P5020080	1	GASKABEL
5	P5010118	1	BBC KABEL
6	P5010044	1	ANTRIEBSKABEL
7	1050002A1	3	MUTTER
8	1050003A1	4	MUTTER
9	P1050014	2	MUTTER
10	P3050147ZB	1	HEBELHALTER
11	P00744998	1	HEBEL
12	P3120226VE	1	BBCLENKER
13	P3060401ZB	1	HALTER
14	P3050158	1	HEBEL
15	P2020168	1	GASHEBEL
16	P3020026ZB	2	FEDER
17	P3020066ZT	1	FEDER
18	P3020065ZB	1	FEDER
19	P3090112ZB	1	PLATTE
20	P4020127	1	PLATTE
21	P1020085	2	PASSSCHEIBE
22	1020007A1	2	FEDERSCHEIBE
23	P1020088	1	SCHEIBE
24	1020013A1	2	FEDERSCHEIBE
25	P2020535	1	SCHACHTELBEDIENUNG SELEM.
26	P2020065	1	STEUERGEHÄUSE
27	P1060012	1	STARLOCK
28	P3100234VE	1	OBERLENKER
29	P01068343ZB	1	HALTER
30	P3100233GR	1	TUBE
31	P1010384	2	SCHRAUBE
32	P1010061	4	SCHRAUBE
33	P1010224	2	SCHRAUBE
34	P1010076	1	SCHRAUBE
35	1010002A1	1	SCHRAUBE
36	P1010163	2	SCHRAUBE

www.emmoproducture.com

**PRO - LITE** 1

**IBEA** 2 4

3 **3 SPEED** 5  
**STOP** 6 ↑

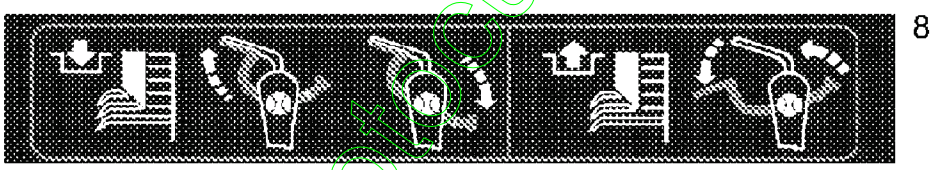
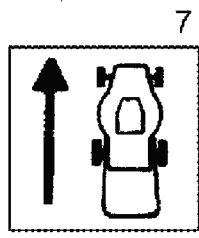
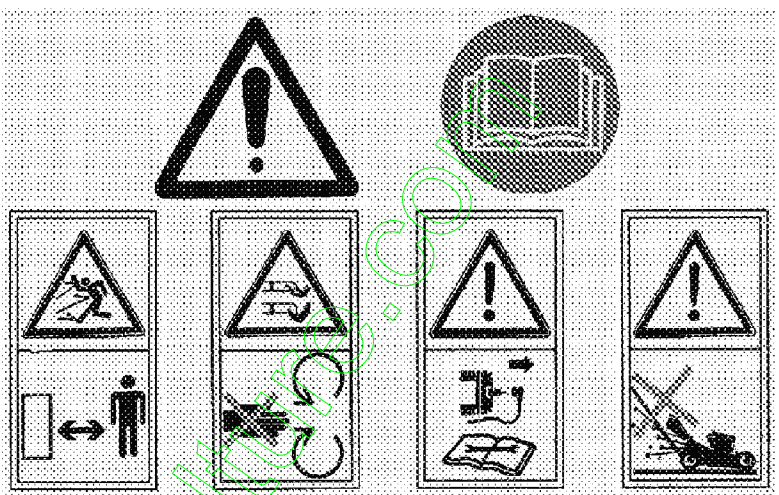

www.emc-motors.com

IB-5395 PLB  
AUFKLEBER

---

Bild Nr.	Teile Nr.	Anzahl	Beschreibung
1	P5140828	1	AUFKLEBER
2	P2020138	1	IBEA AUFKLEBER
3	P5140186	1	ABZIEHBILD
4	P5140334	1	AUFKLEBER
5	P5140202	1	ABZIEHBILD
6	P5140645	1	AUFKLEBER
7	P5140646	1	ANTRIEBAUFKLEBER
8	P5140969	1	AUFKLEBER
*	P5110012	1	KERZENSCHLÜSSEL
*	P5110005	1	SCHLÜSSEL
*	5040001A1	5	RAPBAND
*	P5110022	1	SCHNERPRESSE

[www.emc-motoculture.com](http://www.emc-motoculture.com)

---