

- SRM-3155(SI),3605(SI) - Cylindre, Carter, Piston, Ventilateur

No.1

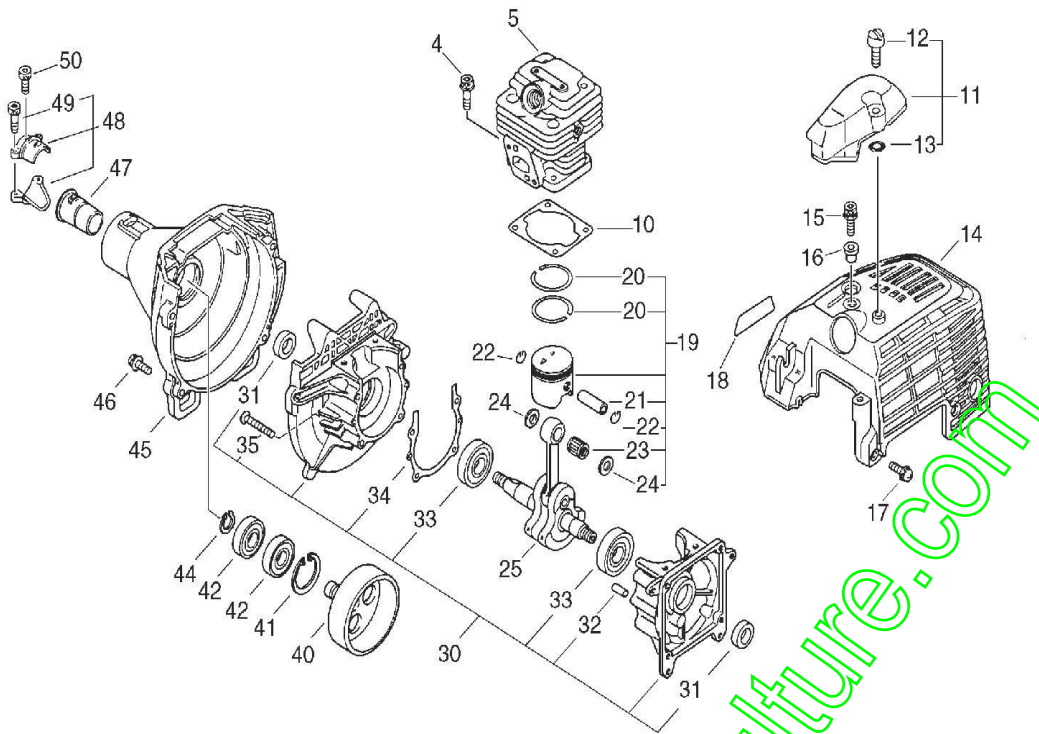

Clé	Ensemble	N° de pièce	Dispo	Description	Quantité	Note
5		A310000601		CYLINDRE	1	SRM-3605/3605SI
10		10101055430		JOINT	1	
11		15990255230		PROTECTEUR	1	
12		35232555230		ECROU	1	
13		90072000004		JOINT TORIQUE	1	
14		10151455630		COUV. CYLINDRE	1	
16		10153155230		RACCORD	1	
18		X503003240		ETIQUETTE	1	SRM-3155SI
19		P021015780		PISTON+AXE+SEGM	1	SRM-3605/3605SI
20		10001142230		SEGMENT	2	SRM-3605/3605SI
21		10001327430		AXE DE PISTON	1	
22		10001503931		JONC D AXE	2	

23		10001216131		CAGE	1	
24		10001453630		ENTRETOISE	2	
25		10010055430		EMBIELLAGE	1	
30		10020455430		CARTER MOTEUR	1	
31		10021305530		JOINT SPI	2	
32		10021503930		=90033040080	4	
33		9403536201		ROULEMENT	2	90081036201 Sus. by 94035-36201
34		V102000040		JOINT CARTER	1	
35		90016205030		VIS	4	
40		17500549930		TAMBOUR	1	
41		90070200028		CIRCLIPS I	1	
42		90080706001		ROULEMENT	2	
44		90070100012		CIRCLIPS E	1	
45		10151155630		COUV.VENTILATEUR	1	
46		90016205020		VIS	4	
47		61091051830		SILENT BLOC	1	61091055630 Sus. by 610910-51830
48		P021012800		SUPPORT	1	
49		90016205025		VIS	2	
50		90016205012		BOULON	1	







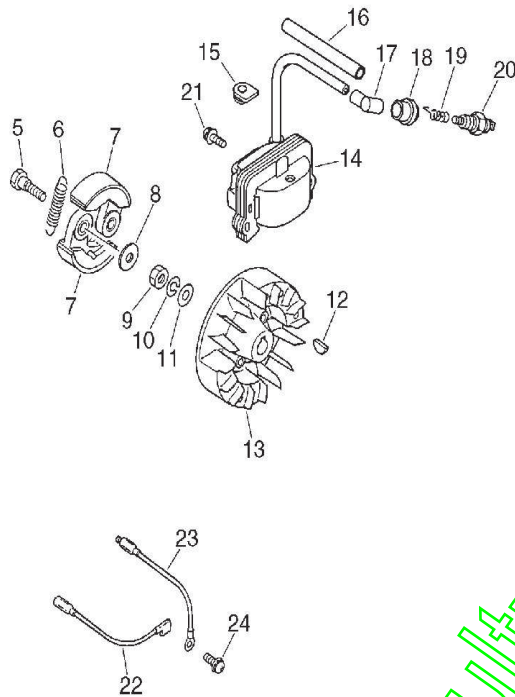

www.enj-motoculture.com

- SRM-3155(SI),3605(SI) - Rotor, Embrayage

No.2





Clé	Ensemble	N° de pièce	Dispo	Description	Quantité	Note
5		17504646430		BOULON	2	
6		17501849933		RESSORT	1	
7		A553000000		PATIN	2	
8		17504805530		RONDELLE	2	
9		90050200008		ECROU ISO BAS	1	
10		90060500008		RONDELLE	1	
11		90060000008		RONDELLE	1	
12		10014212330		CLAVETTE	1	
13		15280155430		ROTOR	1	
14		15262655430		MODULE CDI	1	
15		15011244330		COUVERCLE	1	
16		15061114530		TUBE	1	

17		15901201620		COIFFE	1	
18		15901555230		CAPOT	1	
19		15901103432		RESSORT	1	
20		15901010230		BOUGIE	1	
21		90016205020		VIS	2	
22		16201055630		FIL DE MASSE	1	
23		16201452930		FIL MASSE	1	
24		90023805010		VIS	1	

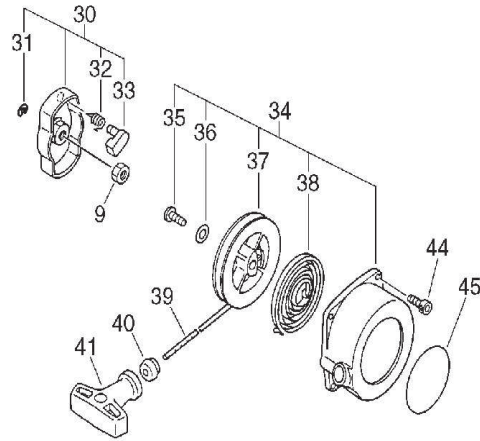
www.emc-motoculture.com



Clé	Ensemble	N° de pièce	Dispo	Description	Quantité	Note
9		90050200008		ECROU ISO BAS	1	SRM-3155/3605
30		17720241030		CLIQUET CPLT	1	SRM-3155/3605
31		90070000004		ANNEAU TRUARC	1	SRM-3155/3605
32		17723440630		RESSORT	1	SRM-3155/3605
33		A514000120		CLIQUET	1	SRM-3155/3605
34		17720055631		LANCEUR CPLT	1	17720055630 Sus. by 177200-55631
35		17723640630		VIS	1	SRM-3155/3605
36		17721441030		RONDELLE	1	SRM-3155/3605
37		17721543130		POULIE LANCEUR	1	SRM-3155/3605
38		17722040630		RESSORT	1	SRM-3155/3605
39		17722601110		CORDE	1	SRM-3155/3605
40		P022045770		GUIDE CORDE	1	SRM-3155/3605

41		17722827030		POIGNEE	1	SRM-3155/3605
44		90016204014		VIS	4	SRM-3155/3605
45		PLUS-LIVRABLE		PLUS-LIVRABLE	1	SRM-3155/3605







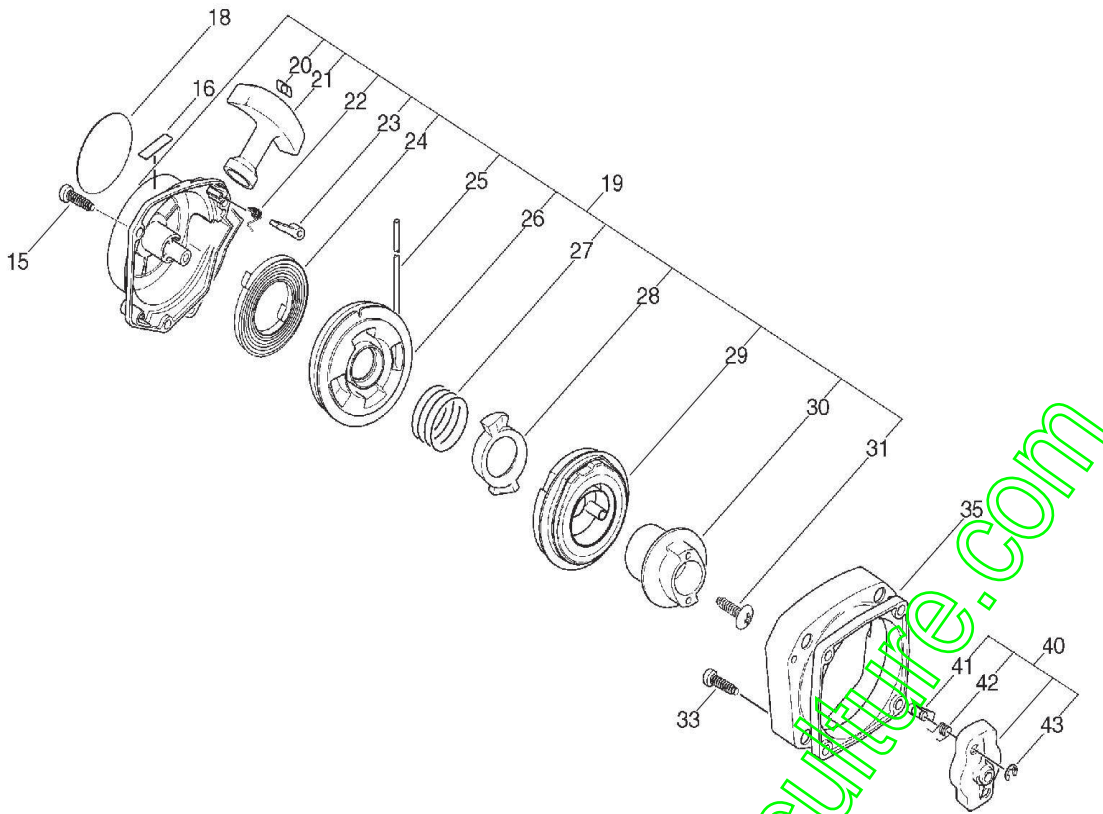









www.emc-motoculture.com

- SRM-3155(SI),3605(SI) - Démarreur(SRM-3155SI/3605SI)

No.4



Clé	Ensemble	N° de pièce	Dispo	Description	Quantité	Note
15		90025305020		MS	3	SRM-3155SI/3605SI
16		X505000620		ETIQUETTE	1	SRM-3155SI/3605SI
18		X502000032		ETIQUETTE	1	SRM-3155SI/3605SI
19		A051000310		LANCEUR CPLT	1	SRM-3155SI/3605SI
20		P022037670		ARRET	1	SRM-3155SI/3605SI
21		17722827030		POIGNEE	1	SRM-3155SI/3605SI
22		P022004610		RESSORT	2	SRM-3155SI/3605SI
23		P022004620		CLIQUET	2	SRM-3155SI/3605SI
24		P022004680		RESSORT	1	SRM-3155SI/3605SI
25		P022004600		CORDE	1	SRM-3155SI/3605SI
26		P022004690		POULIE	1	SRM-3155SI/3605SI
27		P022004660		RESSORT	1	SRM-3155SI/3605SI

28		P022004670		ENTRAINEUR	1	SRM-3155SI/3605SI
29		P022004730		COMPLET MOLLA	1	SRM-3155SI/3605SI
30		P022004720		CAME	1	SRM-3155SI/3605SI
31		P022004630		VIS	1	SRM-3155SI/3605SI
33		90016204014		VIS	4	SRM-3155SI/3605SI
35		V376000280		CARTER	1	SRM-3155SI/3605SI
40		A052000100		CLIQUET CPLT	1	SRM-3155SI/3605SI
41		A514000120		CLIQUET	2	SRM-3155SI/3605SI
42		17723440630		RESSORT	2	SRM-3155SI/3605SI
43		P022002100		CIRCLIPS	2	SRM-3155SI/3605SI







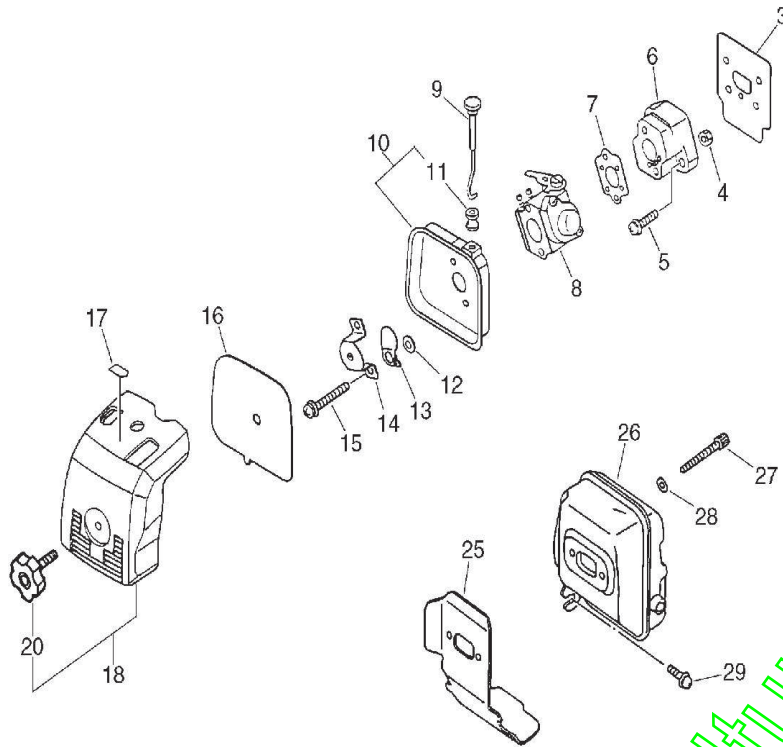





www.emc-motoculture.com

- SRM-3155(SI),3605(SI) - Filtre à air, Echappement

No.5



Clé	Ensemble	N° de pièce	Dispo	Description	Quantité	Note
3		13001655430		JOINT	1	
4		90050000005		ECROU	2	
5		90016205025		VIS	2	
6		13001755630		ISOLANT	1	
7		13001005960		JOINT	1	
8		12300055630		CARBURATEUR	1	
9		17851051730		TIRETTE STARTER	1	
10		13030151730		BOITIER	1	
11		17881005230		PASSE TIGE	1	
12		17851600830		RONDELLE	1	
13		17851505060		VOLET	1	
14		12901152131		SUPPORT	1	12901152130 Sus. by 129011-52131

15		90016205057		BOULON	2	
16		13031051730		FILTRE AIR	1	
17		89012147530		ETIQUETTE	1	
18		13030252132		COUVERCLE	1	
20		13040652131		VERROU	1	13040652130 Sus. by 130406-52131
25		14551055430		JOINT DE POT	1	
26		14561055230		POT	1	
27		90010505060		VIS 6 PANS	2	
28		90060000005		RONDELLE	2	
29		90016205012		BOULON	1	







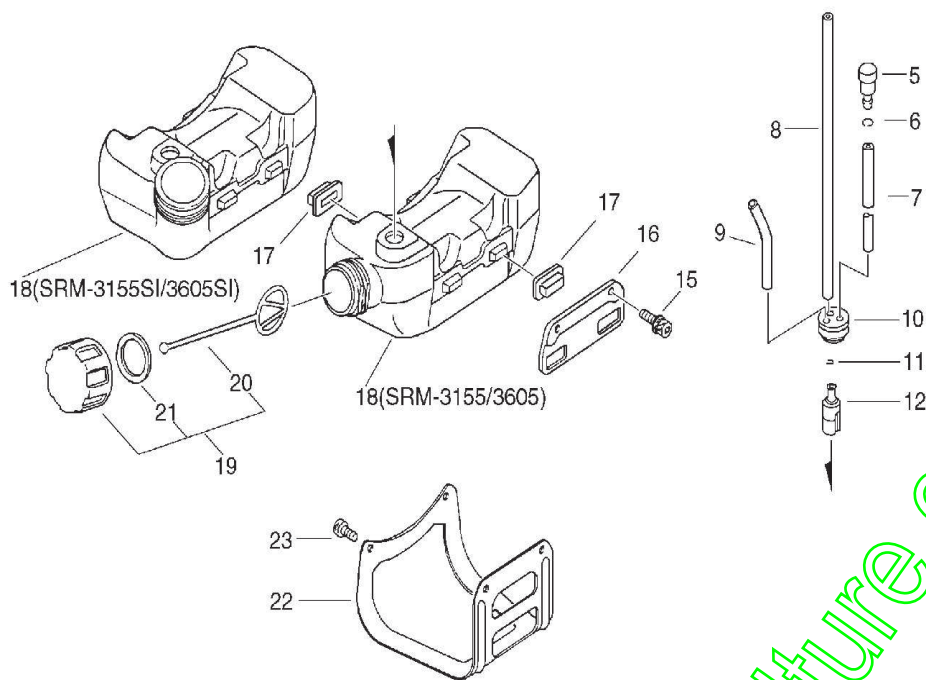

www.emc-motoculture.com

- SRM-3155(SI),3605(SI) - Réservoir à essence

No.6



Clé	Ensemble	N° de pièce	Dispo	Description	Quantité	Note
5		A356000031		EVENT	1	
6		13011100530		CLIP TUYAU	1	
7		V471001210		TUYAU HUILE	1	43721011131 Sus. by V471-001210
8		V471001191		TUYAU	1	
9		13201056330		TUYAU	1	
10		13211546730		PASSE-TIGE	1	
11		V490001240		CLIP	1	
12		A369000470		PLONGEUR Petit B	1	
15		90016205020		VIS	2	
16		13191055430		SUPPORT	1	
17		13192055430		CAOUTCHOUC	4	
18		A350000171		RESERVOIR ESS	1	A350000170 Sus. by A350-000171

19		P100006640		BOUCHON	1	
20		13105156030		RETENUE	1	
21		V107000190		JOINT DE BOUCHON	1	
22		30511055630		PIED FE6	1	
23		90016205012		BOULON	2	

www.emc-motoculture.com

- SRM-3155(SI),3605(SI) - Protecteur(N° série 029420(SRM-3155)/D.S. N° série 023799(SRM-3605) et avant)

No.7

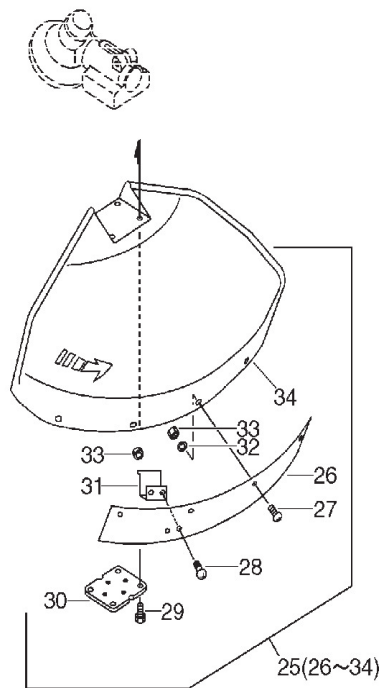

Clé	Ensemble	N° de pièce	Dispo	Description	Quantité	Note
25		69900052931		=P021012620	1	Drive Shaft Sr/Nr 023799 and before/SRM-3605
26		69901352130		BAVETTE	1	Drive Shaft Sr/Nr 023799 and before/SRM-3605
27		90016205018		VIS	4	Drive Shaft Sr/Nr 023799 and before/SRM-3605
28		90016205014		VIS	2	Drive Shaft Sr/Nr 023799 and before/SRM-3605
29		90016205025		VIS	4	
30		C552000200		PLAQUE	1	
31		69901654530		COUPEAU NM	1	69901652130 Sus. by 699016-54530
32		90060300005		RONDELLE	4	Drive Shaft Sr/Nr 023799 and before/SRM-3605
33		90050000005		ECROU	6	Drive Shaft Sr/Nr 023799 and before/SRM-3605
34		69901052931		PROTECTEUR	1	69901052930 Sus. by 699010-52931

www.emc-motoculture.com