

**NOTE: ALWAYS USE ORIGINAL EQUIPMENT PARTS.** Use of service/replacement parts other than original equipment parts may void your warranty.

**ALL UNNUMBERED ITEMS ARE INTERCHANGEABLE WITH OPPOSITE SIDE**

KEY#	PART#	DESCRIPTION	QTY
1	338480-824	FRAME, RER	1
2	309612	FOOT PAD, RH	1
3	309613	FOOT PAD, LH	1
4	309235	FASTENER, RATCHET	12
5	335835	CONSOLE C-2	1
6	995346	SCREW, 1/4-20 X .50	4
7	303130	HEADLIGHT ASSEMBLY	1
8	303260	CLIP, TINNEMAN	4
9	308347	SCREW, #6-32 X .50	4
10	330969-824	SUPPORT, SEAT	1
11	48901	SCREW, 5/16-18 X .63	2
12	180077	SCREW, 5/16-18 X .75	2
13	1498	NUT, 5/16-18	4
14	301330-853	SEAT BRACKET	1
15	180120	SCREW, 3/8-16 X .75	2
16	1499	NUT, 3/8-16	2
17	316128-853	ASSEMBLY, PLATE, SEAT	1
18	20507	BOLT, .437 X .156	2
19	1498	NUT, 5/16-18	2
20	331106-853	SEAT/SHIFT SUPPORT	1
21	180079	SCREW, 5/16-18 X 1.00	2
22	1498	NUT, 5/16-18	2
23	35498	SCREW, 5/16-18 X .75	1
24	180077	SCREW, 5/16-18 X .75	2
25	45602	WASHER, FLAT .333 X .87 X .119	2
26	1498	NUT, 5/16-18	2
27	330463	SPRING, SEAT	1
28	120392	WASHER, FLAT .281 X .63 X .065	1
29	180016	SCREW, 1/4-20 X .50	1
30	1502	NUT, 1/4-20	1
31	53446	PIN, 5/16-18 HOOD LATCH	2
32	120386	WASHER, FLAT .312 X .73 X .065	6
33	124824	NUT, 5/16-18	2
34	335826	FENDER, RER	1
35	44811	SCREW, 1/4-20 X .75	4
36	305645	FENDER SUPPORT	2
37	995346	SCREW, 1/4-20 X .50	4
38	12599	FASTENER, VELCRO	2
	318307	GRASS CATCHER MANUAL (ENGLISH)	1
	318355	GRASS CATCHER MANUAL (FRENCH)	1
	318354	GRASS CATCHER MANUAL (GERMAN)	1
	339410	OPERATOR'S MANUAL	1

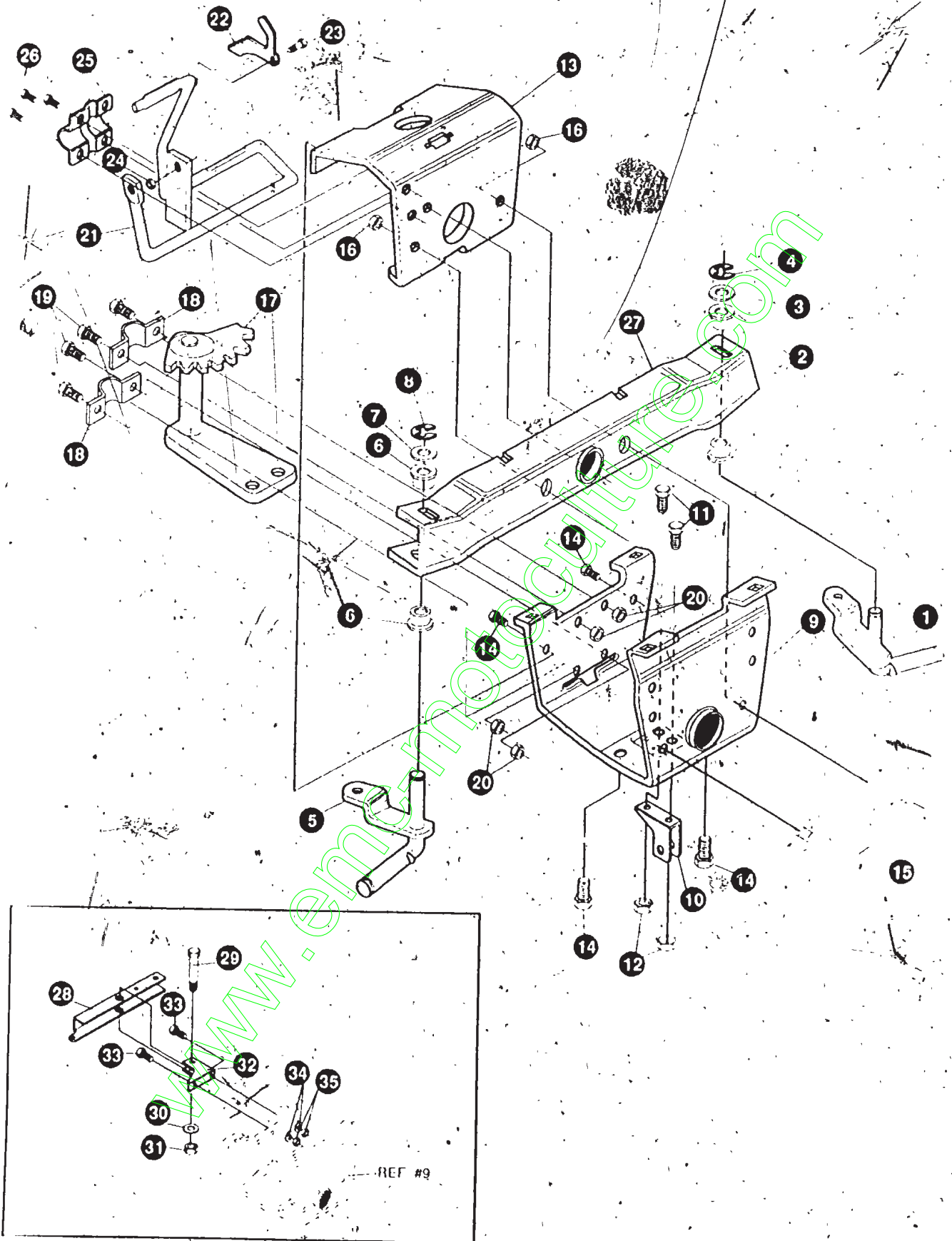

**NOTE: ALWAYS USE ORIGINAL EQUIPMENT PARTS.** Use of service/replacement parts other than original equipment parts may void your warranty.

**ALL UNNUMBERED ITEMS ARE INTERCHANGEABLE WITH OPPOSITE SIDE**

KEY#	PART#	DESCRIPTION	QTY
1	316216	ASSEMBLY, SPINDLE, LH.....	1
2	12552	BUSHING, SPINDLE.....	2
3	4107	WASHER, FLAT .635 X 1.31 X .07.....	2
4	20859	RING, RET E.....	1
5	316217	ASSEMBLY, SPINDLE, RH.....	1
6	12552	BUSHING, SPINDLE.....	2
7	4107	WASHER, FLAT .635 X 1.31 X .07.....	2
8	20859	RING, RET E.....	1
9	314228	BRACKET, AXLE, OUTER, FRONT.....	1
10	323904	HANGER.....	1
11	180077	SCREW, 5/16-18 X .75.....	2
12	1498	NUT, 5/16-18.....	2
13	338440	AXLE BRACKET, INNER.....	1
14	35497	SCREW, 5/16-18 X .50.....	4
15	180138	SCREW, 3/8-16 X 3.00.....	2
16	1498	NUT, 3/8-16.....	2
17	302958	STEERING ASSEMBLY.....	1
18	302760	CLAMP.....	2
19	180077	SCREW, 5/16-18 X .75.....	4
20	1498	NUT, 5/16-18.....	4
21	338888	BRAKE ARM ASSEMBLY.....	1
22	302955	LATCH, PARKING BRAKE.....	1
23	3275	BOLT, .373 X .140.....	1
24	1502	NUT, 1/4-20.....	1
25	44112	BRACKET, CLUTCH & BRAKE.....	1
26	35497	SCREW, 5/16-18 X .50.....	4
27	316218	FRONT AXLE ASSEMBLY.....	1
28	309051	ROCKER ARM, MOWER ENGAGEMENT.....	1
29	310364	BOLT, .500 X 1.18.....	1
30	84524	WASHER, FLAT .390 X 1.25 X .119.....	1
31	1499	NUT, 3/8-16.....	1
32	323904	HANGER.....	1
33	180077	SCREW, 5/16-18 X .75.....	2
34	120393	WASHER, FLAT .344 X .69 X .065.....	2
35	1498	NUT, 5/16-18.....	2

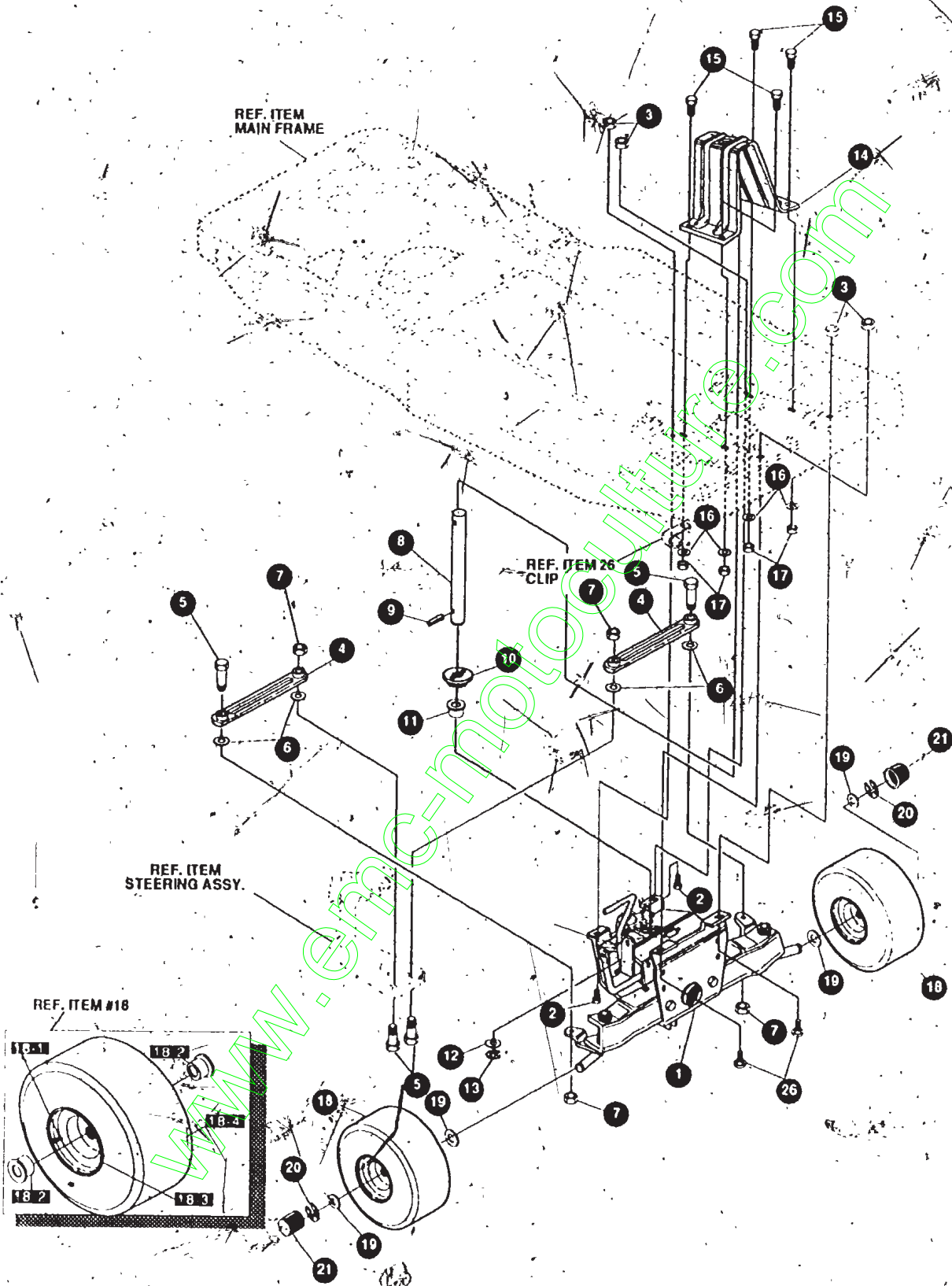

**NOTE: ALWAYS USE ORIGINAL EQUIPMENT PARTS. Use of service replacement parts other than original equipment parts may void your warranty.**

**ALL UNNUMBERED ITEMS ARE INTERCHANGEABLE WITH OPPOSITE SIDE**

6/14  
A-5

KEY#	PART#	DESCRIPTION	QTY
1		FRONT AXLE PIVOTING ASSEMBLY	1
2	57072	BOLT, 5/16-18 X .63	2
3	45174	NUT, 5/16-18	2
4	303140	TIE ROD	4
5	180124	SCREW, 3/8-16 X 1.25	4
6	120382	WASHER, .393 X .68 X .10	4
7	1499	NUT, 3/8-16	4
8	323906	SHAFT, STEERING	1
9	454565	PIN, SPRING	1
10	302766	GEAR, PINION	1
11	304010	BUSHING-STEERING	1
12	4107	WASHER, FLAT .635 X 1.31 X .07	1
13	20859	RING, RET E	1
14	306553	SUPPORT, STEER SHAFT	1
15	48901	SCREW, 5/16-18 X .63	4
16	120393	WASHER, FLAT .344 X .69 X .065	4
17	1498	NUT, 5/16-18	4
18	338183	TIRE & RIM ASSEMBLY, 11 X 4.0-4	2
18-1	338512	VALVE STEM	
18-2	338156	RIM, WHEEL	
18-3	338545	BEARING	
18-4	338168	TIRE, 11 X 4-4	
19	40677	WASHER, FLAT .640 X 1.25 X .06	4
20	20859	RING, RET E	2
21	40394	HUB CAP	2
26	180077	SCREW, 5/16-18 X .75	2

ORDER INDIVIDUAL PARTS - ASSEMBLY NOT AVAILABLE

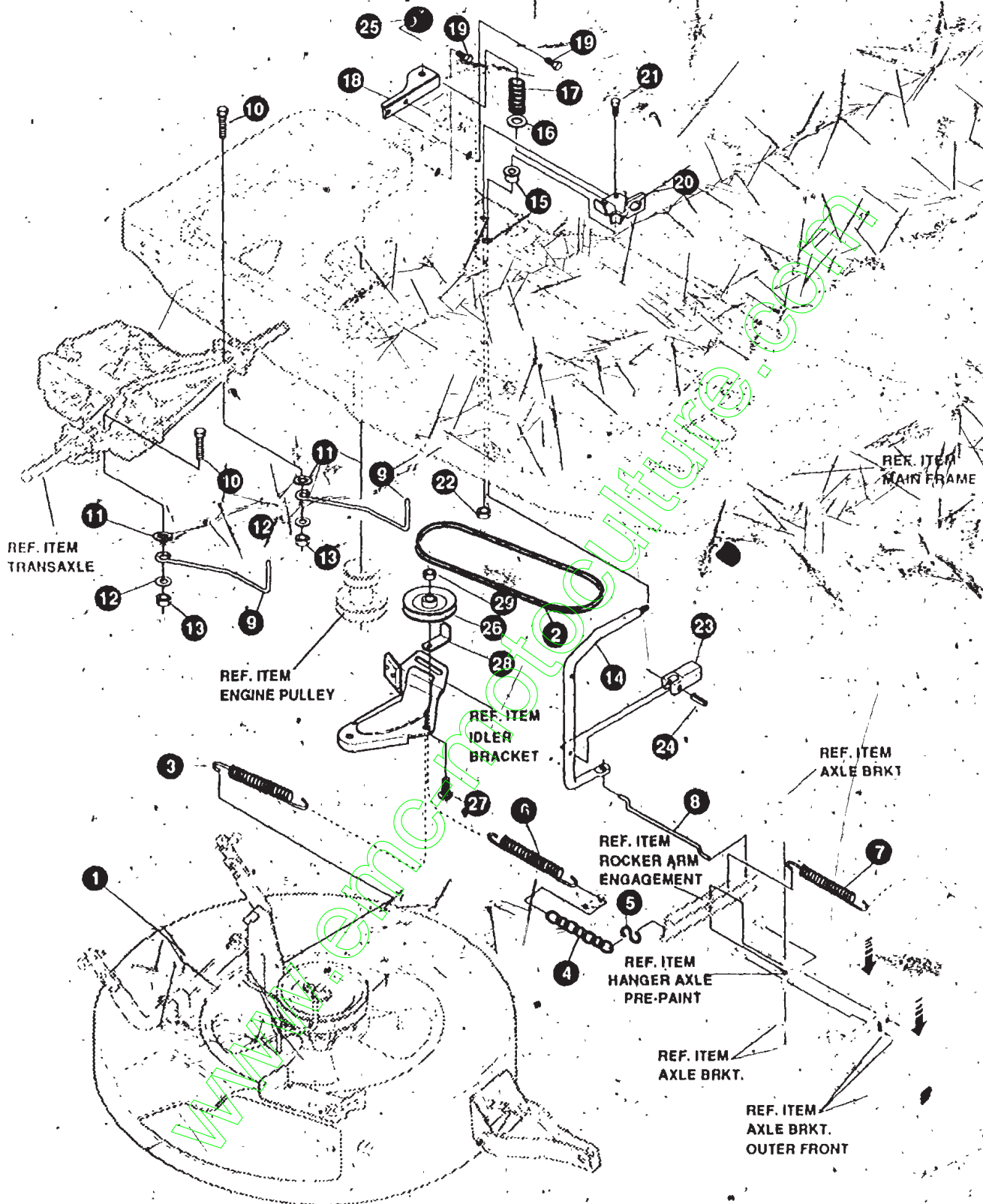

**NOTE: ALWAYS USE ORIGINAL EQUIPMENT PARTS.** Use of service/replacement parts other than original equipment parts may void your warranty.

**ALL UNNUMBERED ITEMS ARE INTERCHANGEABLE WITH OPPOSITE SIDE**

331748 A

KEY#	PART#	DESCRIPTION	QTY
1		ASSEMBLY, DECK, 30"	1
2	56537	BELT, V 4L-50.5" LQ	1
3	35410	SPRING	1
4	334471	KIT CHAIN JACK 310428	5
5	310734	HOOK, S	1
6	300683	SPRING, TENSION	1
7	35410	SPRING	1
8	309049	ROD, CONNECTING	1
9	310388	GUIDE BELT	2
10	180091	SCREW, 5/16-18 X 1.50	2
11	128485	WASHER, 3/20 X .61 X .03	2
12	120393	WASHER, FLAT .644 X .69 X .065	2
13	1498	NUT, 5/16-18	2
14	309048	HANDLE, MOWER ENGAGEMENT	1
15	310351	BEARING, FLANGE	1
16	304291	SPRING, RETAINING	1
17	304398	SPRING COMPRESSION	1
18	311107-853	SUPPORT BRACKET, PTO	1
19	995346	SCREW, 1/4-20 X .50	2
20	310309	BRACKET, PTO LIMIT	1
21	35498	SCREW, 5/16-18 X .75	1
22	1498	NUT, 5/16-18	1
23	305225	STOP, PTO ENGAGE	1
24	326386	PIN, SPRING	1
25	321837	KNOB	1
26	45074	PULLEY, IDLER V4L	1
27	45892	BOLT, 3/8-16 X 1.50	1
28	39659	RETAINER, BELT	1
29	1499	NUT, 3/8-16	1

\* REFERENCE ONLY

www.eric.com



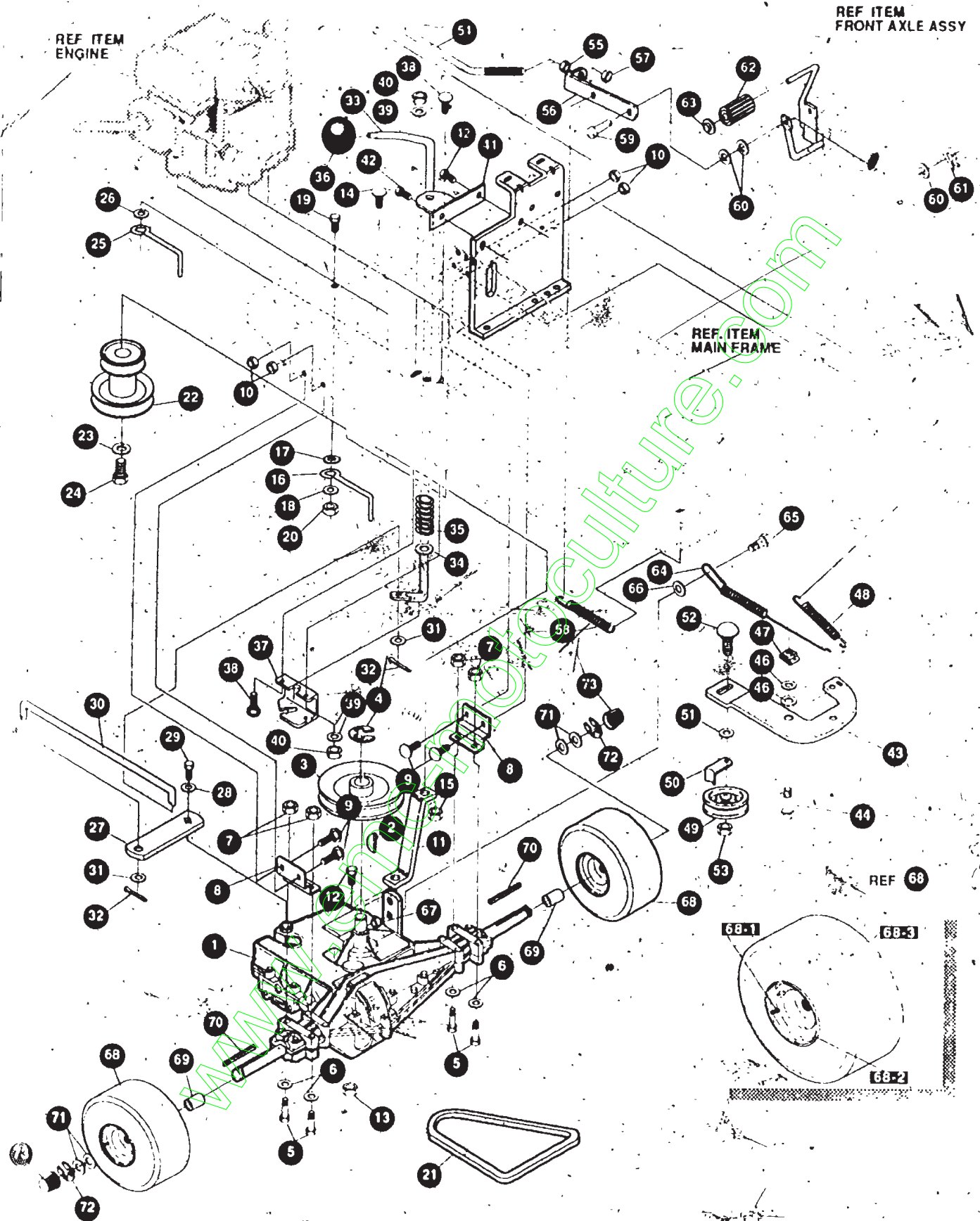

**NOTE: ALWAYS USE ORIGINAL EQUIPMENT PARTS.** Use of service/replacement parts other than original equipment parts may void your warranty.

**ALL UNNUMBERED ITEMS ARE INTERCHANGEABLE WITH OPPOSITE SIDE**

KEY#	PART#	DESCRIPTION	QTY.
1		TRANSAXLE, RER .....	1
2	50795	KEY, HI-PRO .....	1
3	303109	PULLEY, 6.6 OD .....	1
4	22053	RING, RETEX .....	1
5	180113	SCREW, 5/16-18 X 3.00 .....	4
6	120393	WASHER, FLAT .344 X .69 X .065 .....	4
7	1498	NUT, 5/16-18 .....	4
8	9796	BRACKET, TRANSAXLE .....	2
9	57072	BOLT, 5/16-18 X .63 .....	4
10	1498	NUT, 5/16-18 .....	4
11	324199	BRACKET, TRANSAXLE SUPPORT .....	1
12	180087	SCREW, 5/16-18 X 2.00 .....	1
13	1498	NUT, 5/16-18 .....	1
14	57072	BOLT, 5/16-18 X .63 .....	1
15	1498	NUT, 5/16-18 .....	1
16	55488	BELT GUIDE .....	1
17	138489	WASHER, .384 X .69 X .04 .....	1
18	120394	WASHER, FLAT .406 X .81 X .065 .....	1
19	180079	SCREW, 5/16-18 X 1.00 .....	1
20	1498	NUT, 5/16-18 .....	1
21	300575	BELT, V 4L 34.00 .....	1
22	328040	PULLY, ENGINE .....	1
23	120383	WASHER, .459 X .78 X .12 .....	1
24	182761	SCREW, 7/16-20 X 2.50 .....	1
25	55488	BELT GUIDE .....	1
26	138489	WASHER, .384 X .69 X .04 .....	1
27	323874	SHIFT LEVER BRACKET .....	1
28	57157	WASHER, .750 X .250 .....	1
29	56255	SCREW, 1/4-28 X .75 .....	1
30	321482	ROD, CONNECTING, SHIFT .....	1
31	120394	WASHER, FLAT .406 X .81 X .065 .....	2
32	137185	PIN, COTTER .....	2
33	309255	HANDLE, SHIFT .....	1
34	120396	WASHER, FLAT .531 X 1.06 X .095 .....	1
35	301133	SPRING, SHIFT LEVER .....	1
37	309053	BRACKET, DETENT SHIFT .....	1
38	126216	BOLT, 5/16-18 X .75 .....	2
39	120393	WASHER, FLAT .344 X .69 X .065 .....	2
40	1498	NUT, 5/16-18 .....	2
41	303098-853	BRACKET, SHIFT CONTROL .....	1
42	995346	SCREW, 1/4-20 X .50 .....	2
43	12593	PIVOT ARM, IDLER .....	1
44	329989	BOLT, .625 X .135 .....	1
46	45602	WASHER, FLAT .333 X .87 X .119 .....	2
47	301124	TINNERMAN CLIP .....	1
48	35410	SPRING .....	1
49	35374	PULLEY, IDLER V4L .....	1
50	39659	RETAINER, BELT .....	1
51	274517	WASHER, FLAT .406 X .73 X .063 .....	1
52	45892	BOLT, 3/8-16 X 1.50 .....	1
53	1499	NUT, 3/8-16 .....	1
54	323532	ROD, CLUTCH .....	1
55	271184	NUT, 5/16-18 .....	1
56	321378	BRACKET, CLUTCH BRAKE .....	1
57	1498	NUT, 5/16-18 .....	1
58	313854	SPRING, IDLER TRACTION DRIVE .....	1
59	39522	PIN, CLEVIS .....	1
60	120393	WASHER, FLAT .344 X .69 X .065 .....	3
61	8260	PIN, HAIR .....	1
62	52840	FOOT PEDAL .....	1
63	44582	CAP, PUSH-ON .....	1
64	326856	SPRING, BRAKE .....	1
65	326131	BOLT, .495 X .31 .....	1
66	308188	WASHER, FLAT .515 X 1.31 X .09 .....	1
67	1498	NUT, 5/16-18 .....	1
68	692308	TIRE & RIM ASSEMBLY 16 X 6.5-8 .....	2
68-1	338512	VALVE STEM .....	
68-2	338172	RIM, WHEEL .....	
68-3	338170	TIRE, 16 X 6.5-8 .....	
69	300588	SPACER, AXLE .....	2
70	52928	KEY, SQUARE .....	2
71	42815	WASHER, FLAT .755 X 1.53 X .07 .....	4
72	36625	RING, RETEX .....	2
73	40394	HUB CAP .....	2

\* CONTACT YOUR NEAREST TRANSAXLE DEALER FOR PARTS & SERVICE

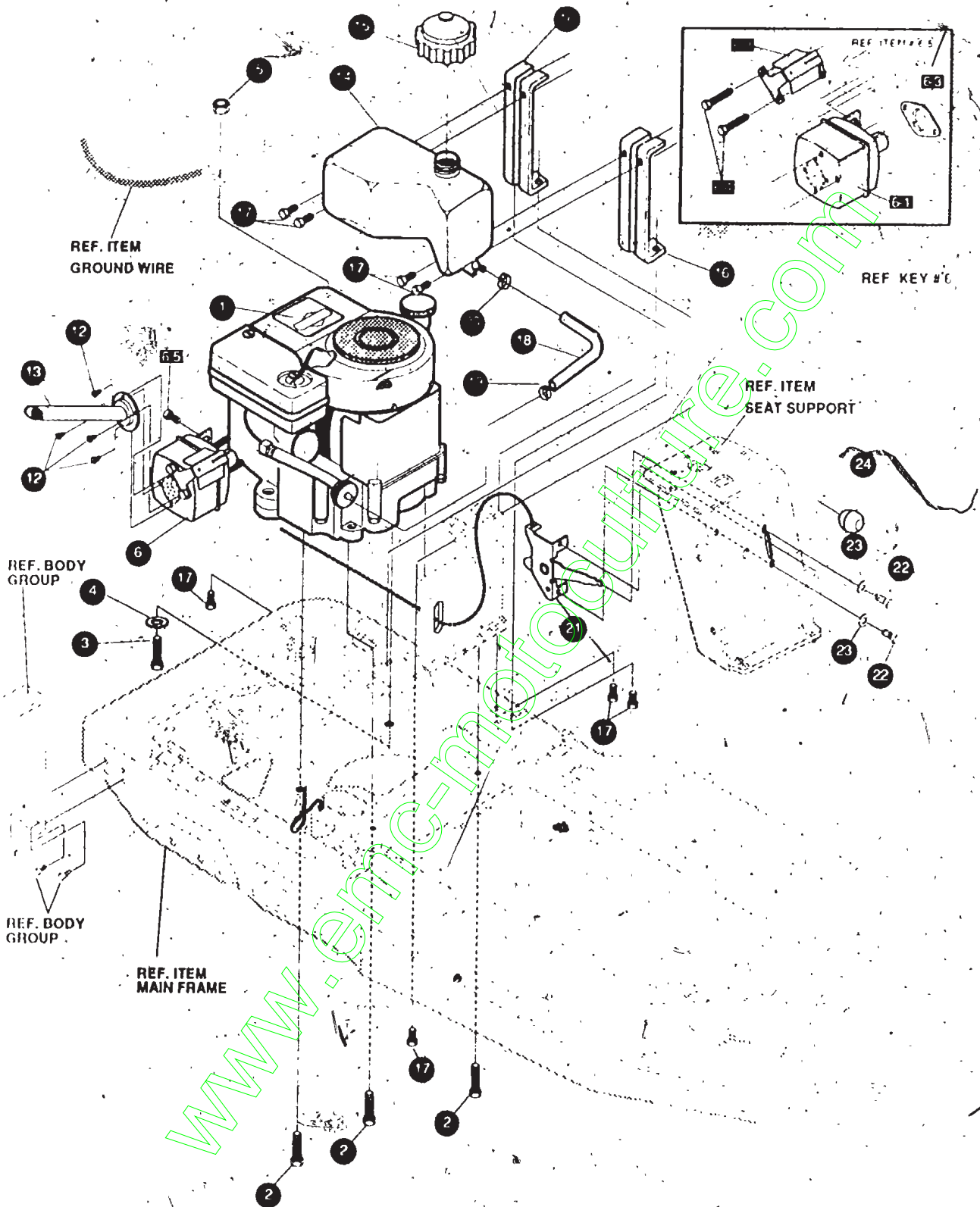

**NOTE: ALWAYS USE ORIGINAL EQUIPMENT PARTS. Use of service/replacement parts other than original equipment parts may void your warranty.**

**ALL UNNUMBERED ITEMS ARE INTERCHANGEABLE WITH OPPOSITE SIDE**

KEY#	PART#	DESCRIPTION	QTY
1		ENGINE, 12-12.5HP .....	1
2	50947	SCREW, 3/8-16 X 1.25 .....	3
3	180083	SCREW, 5/16-18 X 1.50 .....	1
4	138485	WASHER, .320 X .61 X .03 .....	1
5	44108	NUT, 5/16-18 .....	1
6	305404	MUFFLER ASSEMBLY .....	1
6-1	305406	MUFFLER .....	1
6-2	305409	SHIELD, MUFFLER .....	1
6-3	46708	GASKET, MUFFLER .....	1
6-4	305407	BOLT, .437 X 4.340 .....	2
6-5	305410	SCREW, 1/4-20 X .50 .....	1
12	57366	SCREW, 10-16 X .50 .....	4
13	311721-853	PIPE ASSEMBLY .....	1
14	314986	TANK, GAS .....	1
15	12501	CAP, FUEL 2.5" .....	1
16	313150-853	SUPPORT, GAS TANK .....	2
17	995346	SCREW, 1/4-20 X .50 .....	8
18	47216	TUBING, .25 X .50 X BULK GAS LINE .....	22.0'
19	47345	CLAMP, HOSE SCREW TYPE .....	1
20	47345	CLAMP, HOSE SCREW TYPE .....	1
21	321240	THROTTLE CONTROL .....	1
22	35287	SCREW, 1/8-32 X .38 .....	2
23	414106	WASHER, FLAT .188 X .38 X .040 .....	2
24	50607	KNOB, ROUND THROTTLE .....	1

\* SEE ENGINE MANUAL

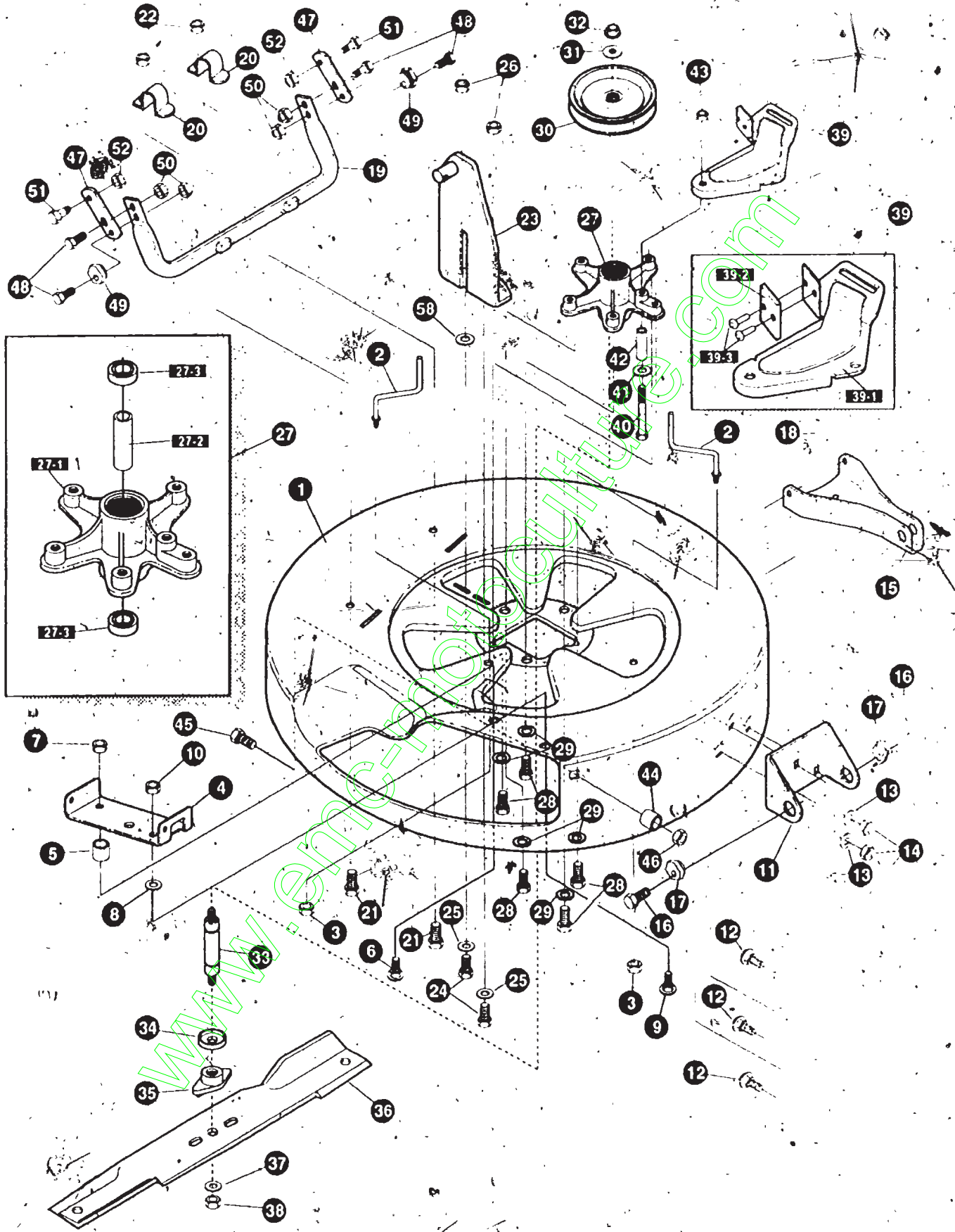

**NOTE: ALWAYS USE ORIGINAL EQUIPMENT PARTS.** Use of service/replacement parts other than original equipment parts may void your warranty.

**ALL UNNUMBERED ITEMS ARE INTERCHANGEABLE WITH OPPOSITE SIDE**

31798D

KEY#	PART#	DESCRIPTION	QTY
1	335308	DECK, MOWER 30'	1
2	57318	GUIDE, BELT	2
3	1498	NUT, 5/16-18	2
4	317017	BRACKET CHUTE MOUNT	1
5	314702	SPACER, SLEEVE	1
6	120230	BOLT, 5/16-18 X 1.25	1
7	1498	NUT, 5/16-18	1
8	45602	WASHER, FLAT .333 X .87 X .119	1
9	126216	BOLT, 5/16-18 X .75	1
10	1498	NUT, 5/16-18	1
11	311237	BRACKET, MOUNTING, FRONT	1
12	57072	BOLT, 5/16-18 X .63	3
13	120393	WASHER, FLAT .344 X .69 X .065	3
14	1498	NUT, 5/16-18	3
15	311236	BRACKET, BAR, TOW, FRONT	1
16	180079	SCREW, 5/16-18 X 1.00	2
17	58247	NUT, ADJUST	2
18	1498	NUT, 5/16-18	2
19	313372	ASSEMBLY, TUBE, PIVOT	1
20	310672	SUPPORT, PIVOT TUBE	2
21	180077	SCREW, 5/16-18 X .75	2
22	1498	NUT, 5/16-18	2
23	314119	ASSEMBLY, LIFT BRACKET	1
24	180077	SCREW, 5/16-18 X .75	2
25	120393	WASHER, FLAT .344 X .69 X .065	2
26	1498	NUT, 5/16-18	2
27	313588	ASSEMBLY, QUILL	1
27-1	314272	QUILL	1
27-2	314274	TUBE, SPACER	1
27-3	313576	BEARING, BALL	2
28	35498	SCREW, 5/16-18 X .75	5
29	138485	WASHER, .320 X .61 X .03	5
30	314273	PULLEY ASSEMBLY	1
31	22265	WASHER, FLAT .515 X 1.38 X .119	1
32	1500	NUT, 1/2-13	1
33	314271	SHAFT, QUILL	1
34	313577	SHIELD, DUST, BEARING	1
35	313584	HUB, BLADE ADAPTOR	1
36	325751	BLADE, 30'	1
37	22265	WASHER, FLAT .515 X 1.38 X .119	1
38	1500	NUT, 1/2-13	1
39	12229	BRACKET, IDLER ASSEMBLY	1
39-1	313510	BRACKET, ARM, IDLER	1
39-2	306973	BRAKE PAD	1
39-3	41601	RIVET	2
40	180091	SCREW, 5/16-18 X 2.50	1
41	45602	WASHER, FLAT .333 X .87 X .119	1
42	314824	SPACER, SLEEVE	1
43	44108	NUT, 5/16-18	1
44	50520	SPACER	1
45	126216	BOLT, 5/16-18 X .75	1
46	1498	NUT, 5/16-18	1
47	314099	BRACKET, BAR, REAR	2
48	180079	SCREW, 5/16-18 X 1.00	4
49	58247	NUT, ADJUST	2
50	1498	NUT, 5/16-18	4
51	51940	BOLT, .500 X .437	2
52	1499	NUT, 3/8-16	2

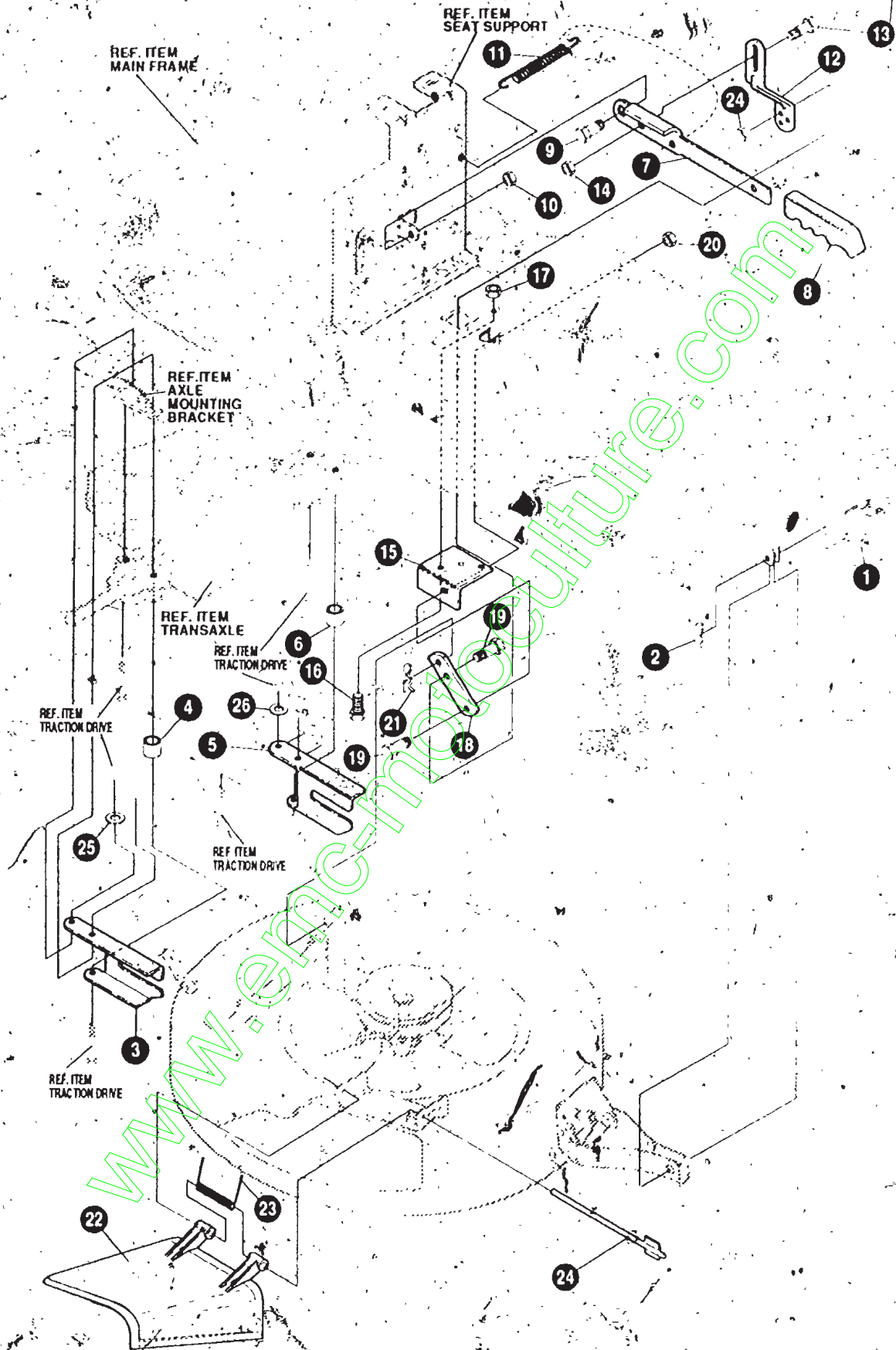

**NOTE: ALWAYS USE ORIGINAL EQUIPMENT PARTS.** Use of service/replacement parts other than original equipment parts may void your warranty.

**ALL UNNUMBERED ITEMS ARE INTERCHANGEABLE WITH OPPOSITE SIDE**

KEY#	PART#	DESCRIPTION	QTY
1	47817	PIN, CLEVIS SHORT .....	1
2	8260	PIN, HAIR .....	1
3	921371	BRACKET, REAR SUPPORT, T RH .....	1
4	41462	SPACER, SLEEVE .....	1
5	321370	BRACKET, REAR SUPPORT, LH .....	1
6	41462	SPACER, SLEEVE .....	1
7	313719-853	HANDLE, HEIGHT ADJUST .....	1
8	313763	GRIP, HANDLE, LIFT .....	1
9	54855	BOLT, .500 X .345 .....	1
10	1499	NUT, 3/8-16 .....	1
11	35410	SPRING .....	1
12	323897	BRACKET, LINK UPPER .....	1
13	54855	BOLT, .500 X .345 .....	1
14	1499	NUT, 3/8-16 .....	1
15	323898	BRACKET, REAR FRAME .....	1
16	180079	SCREW, 5/16-18 X 1.00 .....	1
17	1498	NUT, 5/16-18 .....	1
18	323899	BRACKET, LINK LOWER .....	1
19	313560	BOLT, .500 X .225 .....	2
20	1498	NUT, 5/16-18 .....	2
21	56180	PIN, HAIR .....	1
22	315314	CHUTE DEFLECTOR .....	1
23	314975	SPRING, TORSION .....	1
24	304424	ROD, PIVOT DECK .312D X .75 .....	1
25	73787	WASHER, FLAT .330 X .75 X .793 .....	1
26	73787	WASHER, FLAT .330 X .75 X .793 .....	1

www.ericson.com



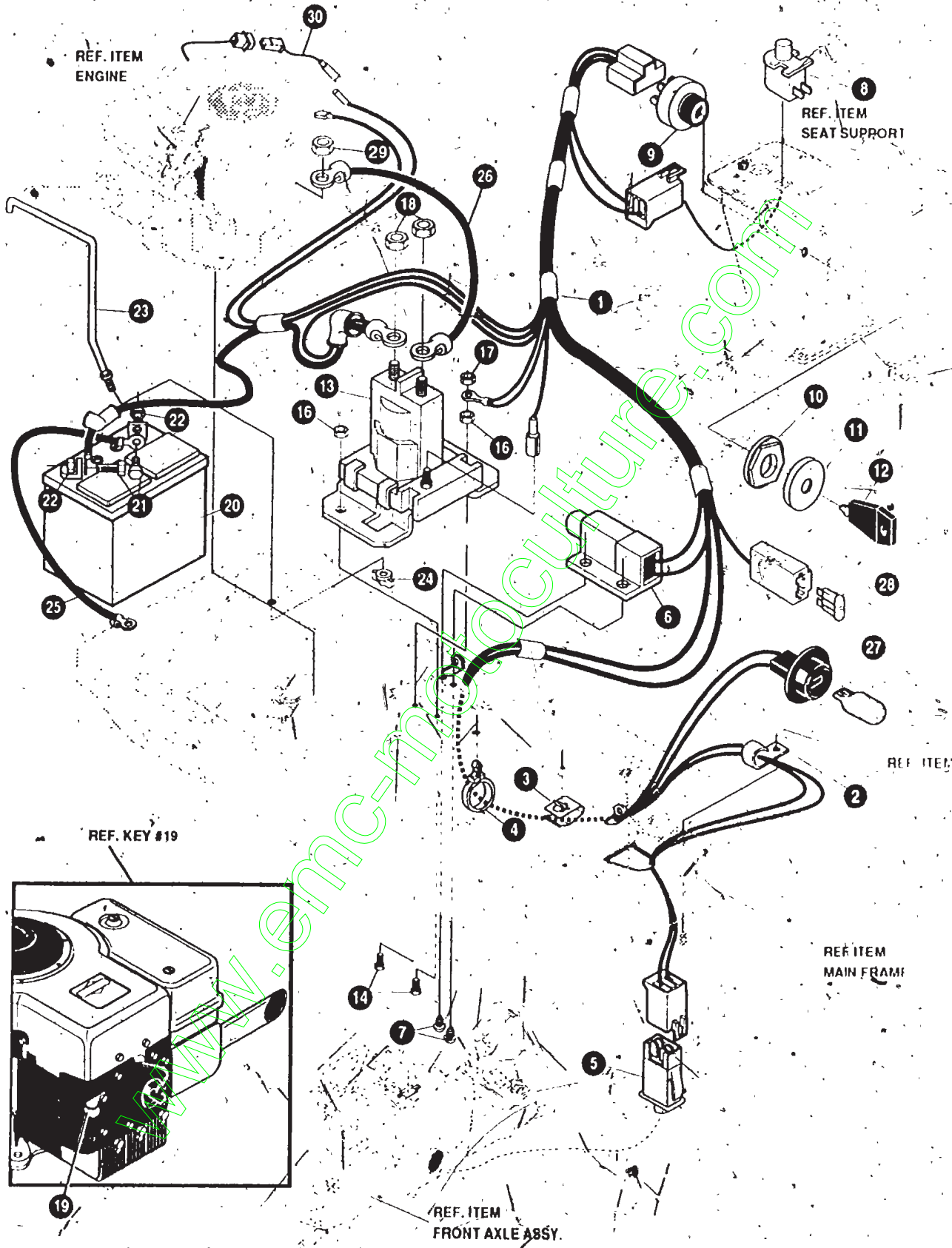

**NOTE: ALWAYS USE ORIGINAL EQUIPMENT PARTS.** Use of service/replacement parts other than original equipment parts may void your warranty.

**ALL UNNUMBERED ITEMS ARE INTERCHANGEABLE WITH OPPOSITE SIDE**

KEY#	PART#	DESCRIPTION	QTY
1	338605	WIRE HARNESS	1
2	57569	RETAINER, WIRE	1
4	309698	CLIP, WIRE ROUTING	2
5	320082	SWITCH, DOUBLE POLE	1
6	57476	SWITCH, SCREW MOUNT	1
7	57220	SCREW, #12 X .50	2
8	326654	SWITCH, SNAP MOUNT	1
9	327354	SWITCH, IGNITION & LIGHTS	1
10	327352	NUT, 5/8-8	1
11	300194	BOOT, IGNITION SWITCH	1
12	327350	KEY, IGNITION	1
13	53716	SOLENOID	1
14	187745	SCREW, 1/4-20 X .75	2
16	1502	NUT, 1/4-20	2
17	271172	NUT, 1/4-20	1
18	271187	NUT, 5/16-24	2
19	57569	RETAINER, WIRE	1
20	302257	BATTERY 12V 7 PLATE	1
21	180020	SCREW, 1/4-20 X .75	2
22	271172	NUT, 1/4-20	2
23	327784	SUPPORT, BATTERY HOLDDOWN	1
24	325232	NUT, WING	1
25	55511	WIRE, GROUND, 12.5"	1
26	322698	WIRE, STARTER	1
27	52572	BULB, HEADLAMP	1
28	302031	FUSE SPADE TYPE 3V 15A	1
29	12469	NUT, 1/4-20	1
30	314669	ADAPTER, HARNESS	1

WIRING SCHEMATIC

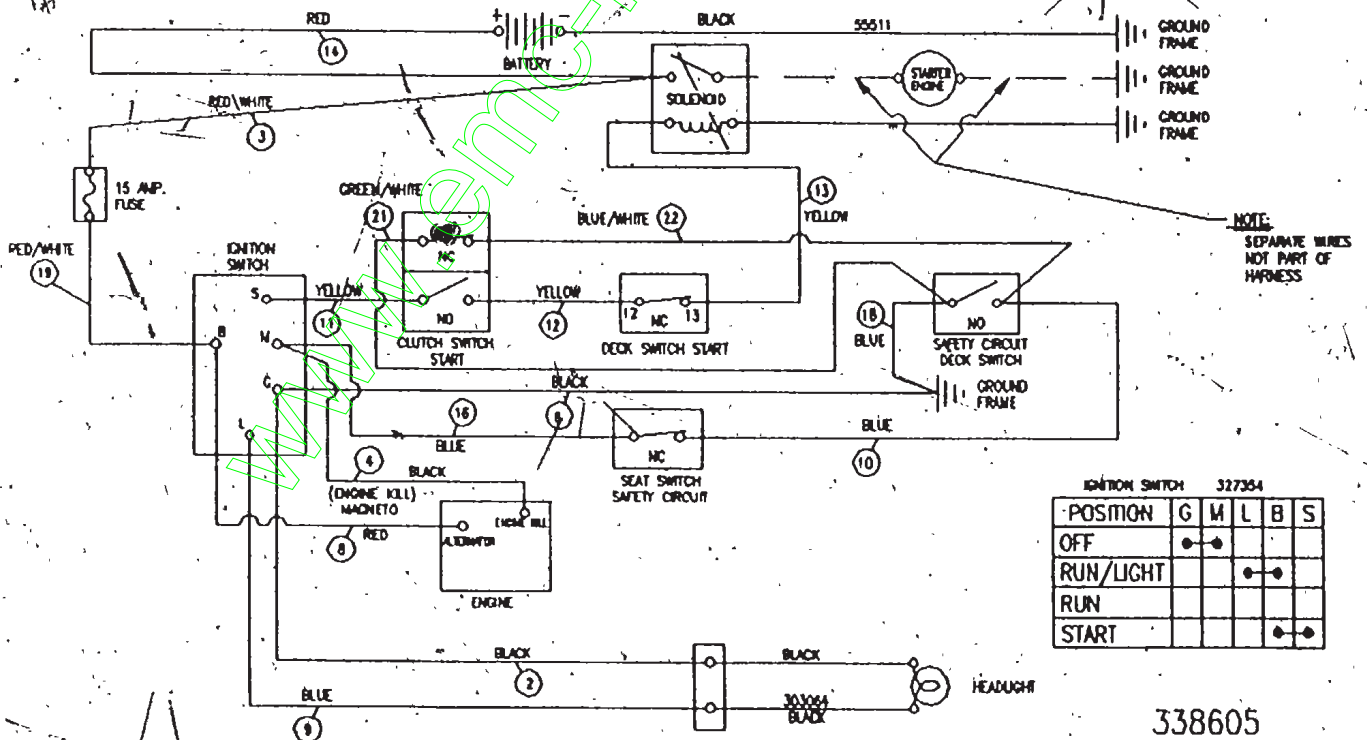

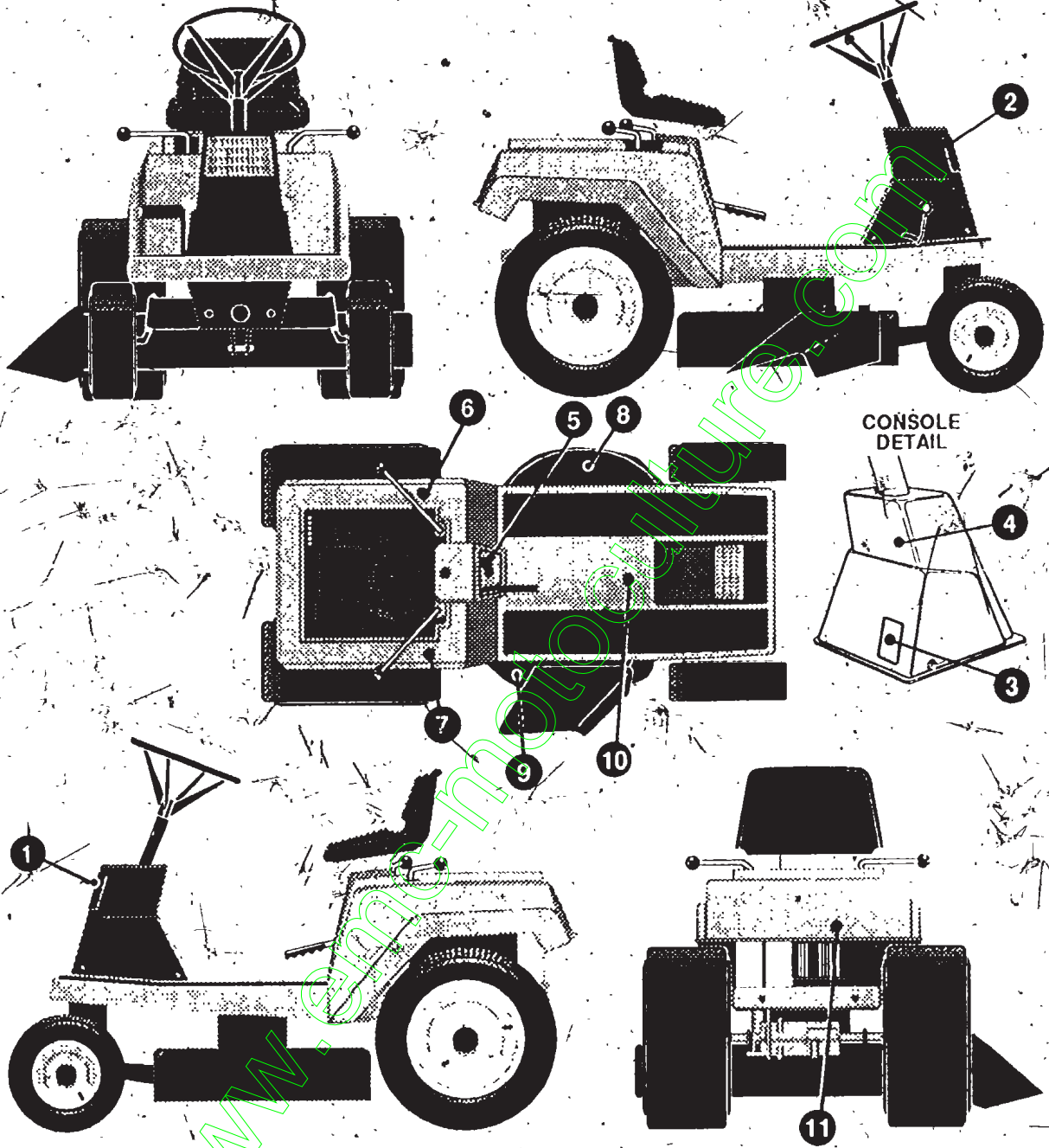

KEY#	PART#	DESCRIPTION	QTY
1	306557	DECAL, LENS, LH.....	1
2	306558	DECAL, LENS, RH.....	1
3	317348	DECAL, PARK'N/BRAKE.....	1
4	311227	DECAL, HEARING PROTECTION.....	1
5	320704	DECAL, CONTROL 30", W/LITE.....	1
6	305392	DECAL, PTO ENGAGEMENT.....	1
7	311232	DECAL, SHIFT, 5SP.....	1
8	402700	DECAL, CAUTION DECK, LH.....	1
9	402701	DECAL, CAUTION DECK, RH, CUT HAND.....	1
10	338540	DECAL, CONS CAUTION.....	1
11	338542	DECAL, DRAWBAR WARNING.....	1

3351860

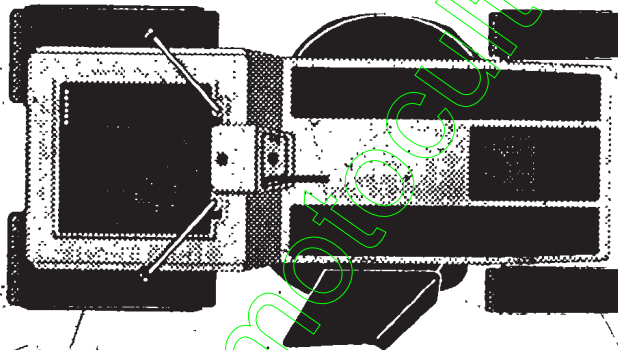
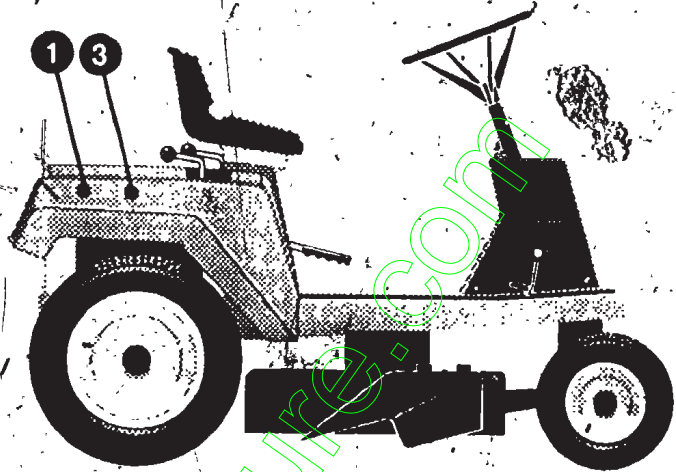
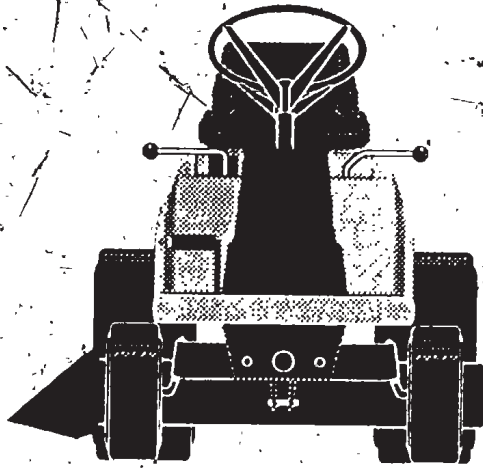

CONSOLE  
DETAIL

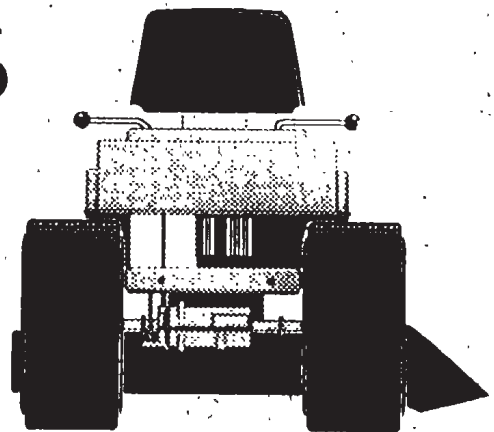
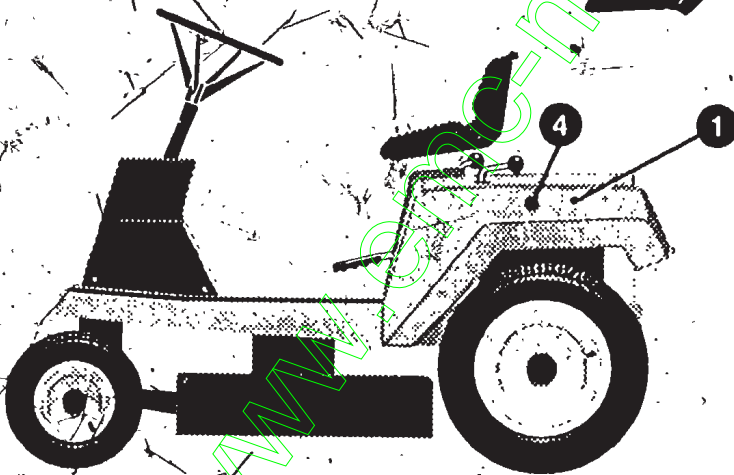
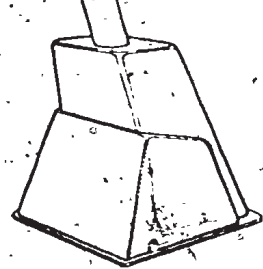

KEY#	PART#	DESCRIPTION	QTY
1	402783	NAMEPLATE, VERTLOISIRS .....	2
3	402782	VERTLOISIRS FENDER STRIPE, RH .....	1
4	402781	VERTLOISIRS FENDER STRIPE, LH .....	1

335832 B

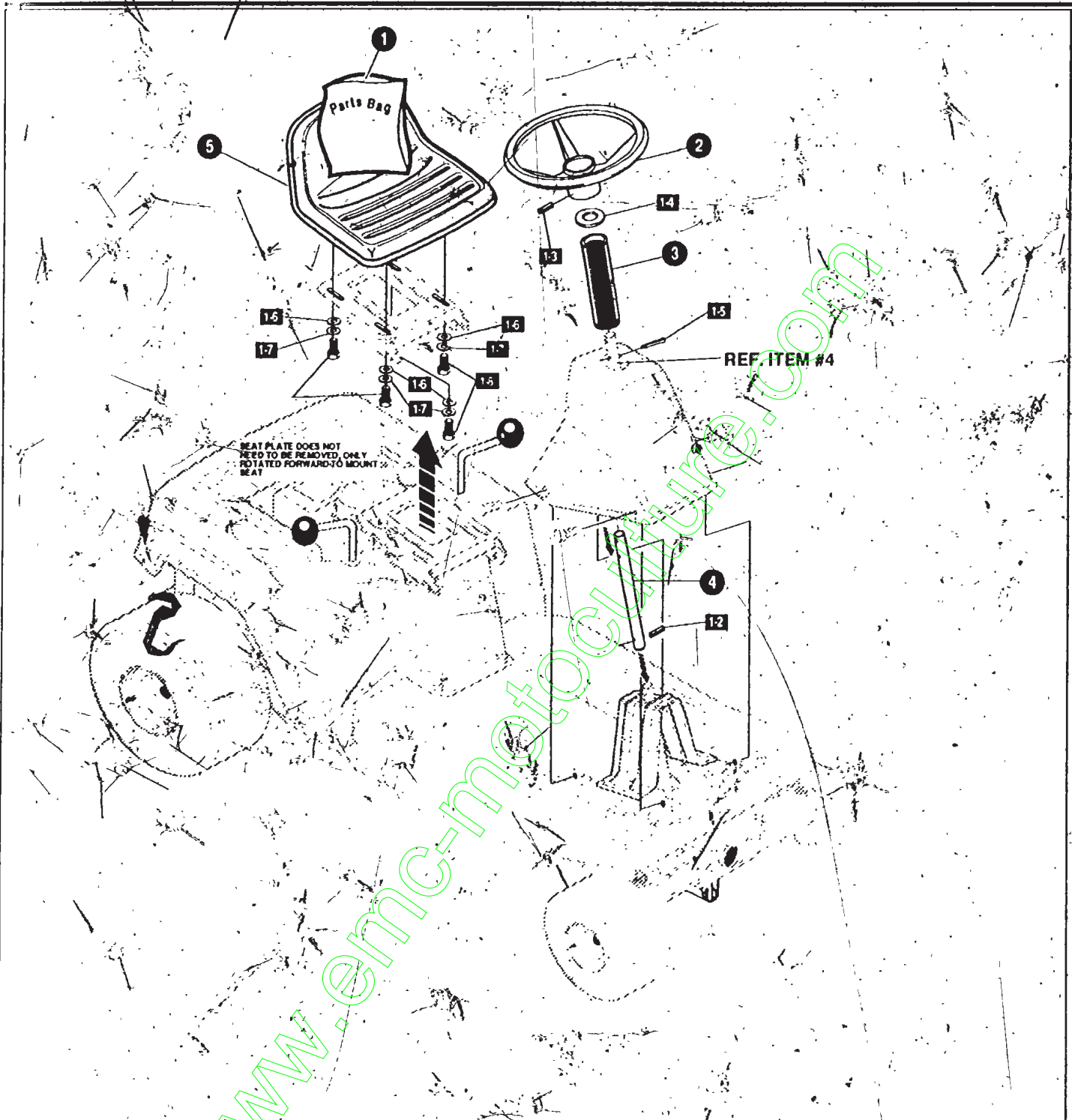

KEY#	PART#	DESCRIPTION	QTY
1	316334	PARTS BAG	1
1-1	55926	BAG, AUTO	1
1-2	417375	PIN, SPRING	1
1-3	456836	PIN, SPRING	1
1-4	301702	WASHER, FLAT .90 X 1.56 X .089	1
1-5	120123	PIN, COTTER	1
1-6	120393	WASHER, FLAT .344 X .69 X .065	4
1-7	120638	WASHER, .328 X .60 X .09	4
1-8	180077	SCREW, 5/16-18 X .75	4
2	301465	STEERING WHEEL, DEEP DISH	1
3	305605	TUBE, DECORATIVE, 6.00" LONG	1
4	300797	STEERING TUBE	1
5	311011	SEAT	1

Contact the dealer where your tractor was purchased for the available accessories. If you are unable to contact the dealer, write to the address on the warranty page of your Operator's manual.

**Rear Engine Rider**

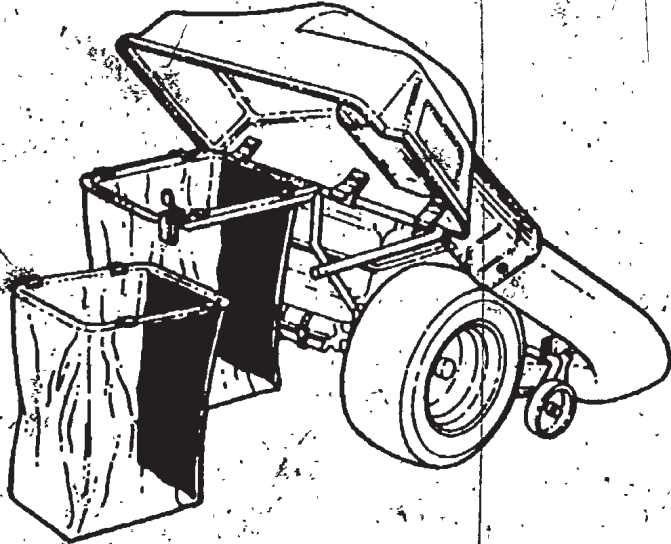

**Model #57081703  
Grass Collector (30" decks)**

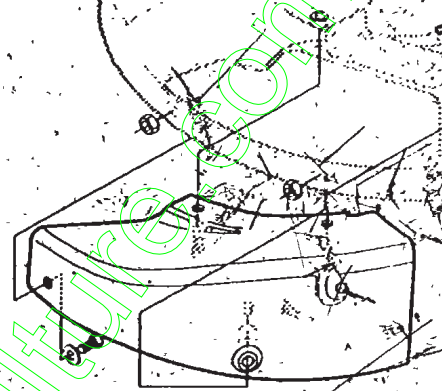

**57140000 Mulching Kit (30" Deck)**

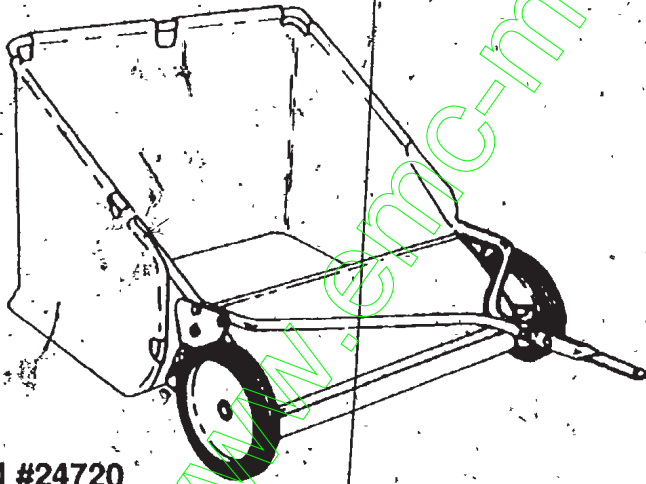

**Model #24720  
Tow Behind Lawn Sweeper for Grass and Leaves**

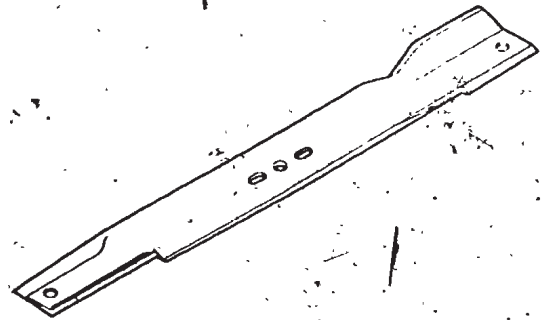

**314275 -30" Standard Lift Blade**

**OTHER ACCESSORIES**

**Model**

**Description**

57090200  
322397

Front Weight Box - holds 35 lbs.  
30" Mulching blade